



riding to 2050

SAN DIEGO REGIONAL BIKE PLAN



SAN DIEGO REGIONAL BICYCLE PLAN

Riding to 2050



401 B Street, Suite 800 • San Diego, CA 92101-4231 • (619) 699-1900

BOARD OF DIRECTORS



The 18 cities and county government are SANDAG serving as the forum for regional decision-making. SANDAG builds consensus; plans, engineers, and builds public transit; makes strategic plans; obtains and allocates resources; and provides information on a broad range of topics pertinent to the region's quality of life.

CHAIR

Hon. Lori Holt Pfeiler

FIRST VICE CHAIR

Hon. Jerome Stocks

SECOND VICE CHAIR

Hon. Jack Dale

EXECUTIVE DIRECTOR

Gary L. Gallegos

CITY OF CARLSBAD

Hon. Matt Hall, Councilmember
(A) Hon. Bud Lewis, Mayor
(A) Hon. Ann Kulchin, Mayor Pro Tem

CITY OF CHULA VISTA

Hon. Cheryl Cox, Mayor
(A) Hon. Rudy Ramirez, Deputy Mayor
(A) Hon. Steve Castaneda, Councilmember

CITY OF CORONADO

Hon. Carrie Downey, Mayor Pro Tem
(A) Hon. Al Ovrom, Councilmember
(A) Hon. Michael Woiwode, Councilmember

CITY OF DEL MAR

Hon. Crystal Crawford, Councilmember
(A) Hon. Mark Filanc, Councilmember
(A) Hon. Richard Earnest, Mayor

CITY OF EL CAJON

Hon. Mark Lewis, Mayor
(A) Hon. Jillian Hanson-Cox, Councilmember

CITY OF ENCINITAS

Hon. Jerome Stocks, Councilmember
(A) Hon. Teresa Barth, Councilmember
(A) Hon. Dan Dalager, Mayor

CITY OF ESCONDIDO

Hon. Lori Holt Pfeiler, Mayor
(A) Hon. Sam Abed, Councilmember

CITY OF IMPERIAL BEACH

Hon. Jim Janney, Mayor
(A) Hon. Patricia McCoy, Mayor Pro Tem
(A) Hon. Jim King, Councilmember

CITY OF LA MESA

Hon. Art Madrid, Mayor
(A) Hon. Mark Arapostathis, Councilmember
(A) Hon. David Allan, Vice Mayor

CITY OF LEMON GROVE

Hon. Mary Teresa Sessom, Mayor
(A) Hon. Jerry Jones, Mayor Pro Tem
(A) Hon. Jerry Selby, Councilmember

CITY OF NATIONAL CITY

Hon. Ron Morrison, Mayor
(A) Vacant
(A) Hon. Rosalie Zarate, Councilmember

CITY OF OCEANSIDE

Hon. Jim Wood, Mayor
(A) Hon. Jerry Kern, Councilmember
(A) Hon. Jack Feller, Councilmember

CITY OF POWAY

Hon. Don Higginson, Mayor
(A) Hon. Jim Cunningham, Councilmember
(A) Hon. Carl Kruse, Deputy Mayor

CITY OF SAN DIEGO

Hon. Jerry Sanders, Mayor
(A) Hon. Anthony Young, Councilmember
(A) Hon. Sherri Lightner, Councilmember
Hon. Ben Hueso, Council President
(A) Hon. Marti Emerald, Councilmember
(A) Hon. Todd Gloria, Councilmember

CITY OF SAN MARCOS

Hon. Jim Desmond, Mayor
(A) Hon. Hal Martin, Vice Mayor
(A) Hon. Rebecca Jones, Councilmember

CITY OF SANTEE

Hon. Jack Dale, Councilmember
(A) Hon. Hal Ryan, Councilmember
(A) Hon. John Minto, Councilmember

CITY OF SOLANA BEACH

Hon. Lesa Heebner, Deputy Mayor
(A) Hon. Dave Roberts, Councilmember
(A) Hon. Mike Nichols, Councilmember

CITY OF VISTA

Hon. Judy Ritter, Mayor Pro Tem
(A) Hon. Bob Campbell, Councilmember
(A) Hon. Steve Gronke, Councilmember

COUNTY OF SAN DIEGO

Hon. Pam Slater-Price, Chairwoman
(A) Hon. Greg Cox, Supervisor
(A) Hon. Ron Roberts, Chair Pro Tem
Hon. Bill Horn, Vice Chair
(A) Hon. Dianne Jacob, Supervisor

IMPERIAL COUNTY

(Advisory Member)
Hon. Wally Leimgruber, District 5 Supervisor
(A) Hon. David Ouzan, Councilmember

CALIFORNIA DEPARTMENT OF TRANSPORTATION

(Advisory Member)
Vacant, Director
(A) Laurie Berman, District 11 Director

METROPOLITAN TRANSIT SYSTEM

(Advisory Member)
Harry Mathis, Chairman
(A) Hon. Ron Roberts
(A) Hon. Jerry Selby

NORTH COUNTY TRANSIT DISTRICT

(Advisory Member)
Hon. Bob Campbell, Chairman
(A) Hon. Carl Hilliard, Planning Committee Chair
(A) Hon. Dave Roberts, Monitoring Committee Chair

U.S. DEPARTMENT OF DEFENSE

(Advisory Member)
CAPT Keith Hamilton, USN, CEC,
Southwest Division Naval Facilities Engineering Command
(A) CAPT James W. Wink, USN, CEC
Southwest Division Naval Facilities Engineering Command

SAN DIEGO UNIFIED PORT DISTRICT

(Advisory Member)
Scott Peters, Commissioner
(A) Stephen Padilla, Commissioner

SAN DIEGO COUNTY WATER AUTHORITY

(Advisory Member)
Mark Muir, Director
(A) Howard Williams, Director
(A) Gary Croucher, Director

SOUTHERN CALIFORNIA TRIBAL CHAIRMEN'S ASSOCIATION

(Advisory Member)
Hon. Edwin 'Thorpe' Romero,
Barona Band of Mission Indians
Hon. Allen Lawson,
San Pasqual Band of Diegueño Indians
(A) Denis Turner, SCTCA Executive Director

MEXICO

(Advisory Member)
Hon. Remedios Gómez-Arnau
Cónsul General of Mexico
Hon. Martha E. Rosas,
Deputy Cónsul General of Mexico

San Diego Regional Bicycle Plan Acknowledgments

Many individuals aided in the preparation of material contained in this San Diego Regional Bicycle Plan. In Particular, the cooperation and involvement of members of various SANDAG committees and working groups are acknowledged.

SANDAG COMMITTEES AND WORKING GROUPS

Transportation Committee

Regional Planning Committee

Bicycle Pedestrian Working Group

Cities/County Transportation Advisory Committee

Regional Planning Technical Working Group

COMMUNITY BASED ORGANIZATIONS

San Diego County Bicycle Coalition

SANDAG STAFF

Gary Gallegos, Executive Director

Renée Wasmund, Chief Deputy Executive Director

Julie Wiley, General Counsel

Charles “Muggs” Stoll, Director of Land Use and Transportation Planning

Jim Linthicum, Director of Mobility Management and Project Implementation

Colleen Windsor, Communications Director

Chris Kluth, Associate Transportation/Land Use Planner, Project Manager

Coleen Clementson, Principal Regional Planner

Stephan Vance, Senior Regional Planner

Susan Baldwin, Senior Regional Planner

Jack Boda, Director of Mobility Management and Project Implementation*

Christine Eary, Associate Regional Planner
Maria Filippelli, Regional Planner
Andrew Gordon, Research Analyst
Carolina Gregor, Senior Regional Planner
Dean Hiatt, Senior Transportation Engineer
David Hicks, Senior Public Information Officer
Bob Leiter, Director of Land Use and Transportation Planning*
Andrew Martin, Associate Regional Planner
Dan Martin, Principal Regional Planner
Jose Nuncio, Manager of Financial Programming and Project Control
Rob Rundle, Principal Regional Planner
Alexia Spivey, Associate Contracts and Procurement Analyst
Lisa Starace, Associate Graphic Designer
Scott Strelecki, Regional Planner
Midori Wong, Regional Planner

*Retired

CONSULTANT TEAM

Alta Planning + Design

Sam Corbett, Senior Associate
Bridget Enderle, Planner
Brett Hondorp, Principal
Sasha Jovanovic, Planner
Sherry Ryan, PhD, Senior Associate

CityWorks

Catherine Smith, JD

RBF Consulting

Mathew Capuzzi, PE
Henry Trang, PE

Table of Contents

Executive Summary	1
Bicycle Infrastructure Improvements	1
Recommended Programs	2
1 Introduction	3
1.1 Setting	4
1.2 Benefits of Being a Bicycle Friendly Region	6
1.2.1 Environmental/Climate Change Benefits	6
1.2.2 Public Health Benefits.....	6
1.2.3 Economic Benefits.....	7
1.2.4 Community/Quality of Life Benefits	8
1.2.5 Safety Benefits	8
1.3 Role of the Regional Bicycle Plan	8
1.4 Major Recommendations of the Plan	9
1.4.1 Bicycle Infrastructure Improvements.....	9
1.4.2 Recommended Programs.....	10
1.5 Overview of the Plan Contents	11
2 Goals, Objectives, and Policy Actions	13
2.1 Goals	13
2.2 Objectives and Policy Actions	14
3 Recommended Regional Bicycle Network	19
3.1 Existing Bikeways	19
3.2 Regional Bikeways in the 2030 RTP	23
3.3 Network Planning Process	23
3.4 Regional Corridor Classifications	27
Class I – Bike Path	28
Class II - Bike Lanes	28
Class III - Bike Routes	28
Cycle Tracks.....	29
Bicycle Boulevards	29
3.5 The Regional Bicycle Network	30

3.6	Priority Projects	33
3.6.1	Project Prioritization Process	33
3.7	Regional Bicycle Parking	34
4	Recommended Programs.....	39
4.1	Education Programs	40
	Complete Streets Education	40
	Driver’s Education & Diversion Courses	41
	Safe Routes to School – Phase 1	42
	Cycling Skills & Safety Courses (Adult & Youth).....	44
4.2	Public Awareness Campaigns & Marketing.....	45
	Bike to Work Month	46
	Share the Road Campaign/Street Smarts	46
	Share the Path Campaign	48
4.3	Encouragement Programs.....	49
	Bike Sharing Program.....	49
	Pilot Smart Trips Program.....	50
	Employer Incentive Programs.....	52
	Bicycle Friendly Community Designation	53
	San Diego Region Bike Map.....	54
	Identification & Way-finding Signage	55
	University-Based Bike Orientation.....	55
4.4	Enforcement Programs.....	56
	Bike Patrol Units & Sting Operations	57
4.5	Monitoring & Evaluation	57
	Annual Evaluation Program.....	58
	Bicycle Coordinators & Bicycle Advisory Committees (BACs)	59
5	Air Quality Benefits of Regional Bicycle Network	
	Implementation	61
5.1	Current System Usage	61
5.2	Potential Future Usage and Air Quality Benefits	62
6	Implementation and Financing	67
6.1	Costing Methods and Estimates.....	67

6.3	Funding Sources	72
6.3.1	Regional Funding Sources	72
6.3.2	Federal Funding Sources	73
6.3.3	State Funding Sources.....	76
6.4	Implementation	77
6.4.1	Project Development.....	77
6.4.2	Environmental Review.....	78
6.4.3	Project Financing.....	79
6.5	Program Monitoring.....	79
6.5.1	Regularly Revisit Project Prioritization.....	80
6.5.2	Update the Plan.....	80
6.5.3	Establish Measures of Effectiveness	80
7	Bicycle Design Guidelines	83
7.1	Design References	84
7.2	Design Principles	85
7.3	Standard Designs of Bicycle Facilities	85
7.4	Innovative Treatments and Signage	100
7.5	Bicycle Parking.....	110

List of Tables

Table 1.1	Existing Regional Land Uses	4
Table 3.1	Bicycle Facilities in the Region	20
Table 3.2	Existing Bicycle Facilities by Jurisdiction	22
Table 3.3	Regional Corridor Classification System	28
Table 3.4	Facility Type and Mileage for the Regional Bicycle Network.....	30
Table 3.5	Land Use and Transit Targets for RCP Smart Growth Place Types	34
Table 3.6	SANDAG iCommute Bike Lockers	35
Table 5.1	Journey to Work Data	61
Table 5.2	Bicycle Commute and Air Quality Projections	64

Table 6.1 Unit Costs Used for Estimating Costs of Regional Bicycle Network68

Table 6.2 Regional Bicycle Network Cost Estimate69

Table 6.3 Active Transportation Program Funds73

Table 6.4 Federal Transportation Enhancement Program Revenue Estimates*74

Table 6.5 Potential Measures of Effectiveness81

List of Figures

Figure 1-1: Existing Land Uses5

Figure 3-1: Existing Local and Regional Bicycle Facilities in San Diego County.....21

Figure 3-2: Regional Bicycle Facilities (2030 RTP).....24

Figure 3-3: Updated Preferred Regional Bicycle Network25

Figure 3-4: New and Realigned Corridors26

Figure 3-5: Regional Bicycle Network Corridor Alignments and Classifications.....31

Figure 3-6: Existing/Planned Facilities in Regional Corridors.....32

Executive Summary

The San Diego Regional Bicycle Plan (Plan) proposes a vision for a diverse regional bicycle system of interconnected bicycle corridors, support facilities, and programs to make bicycling more practical and desirable to a broader range of people in our region. This vision is intended to guide the development of the regional bicycle system through the year 2050.

Planning for a more bicycle friendly region helps to resolve multiple complex and interrelated issues, including, traffic congestion, air quality, climate change, public health, and livability. By guiding the region toward the creation of a substantial regional bicycle network, this plan can affect all of these issue areas, thereby improving existing and future quality of life in the San Diego region.

The Plan outlines a range of recommendations to facilitate accomplishing the regional goals of increasing the number of people who bike and frequency of bicycle trips for all purposes, encouraging the development of Complete Streets¹, improving safety for bicyclists, and increasing public awareness and support for bicycling in the San Diego region. The recommendations include bicycle infrastructure improvements, bicycle-related programs, implementation strategies, and policy and design guidelines. Key recommendations are outlined below.

Bicycle Infrastructure Improvements

The Plan presents an interconnected network of bicycle corridors that would enable residents to bicycle with greater safety, directness, and convenience within and between major regional destinations and activity centers. The regional bicycle network consists of a combination of standard bicycle facilities, including Class I bike paths, Class II bike lanes, and Class III bike routes which are described and depicted in greater detail in Table 3.3. The Plan also proposes two facility types that are not defined as bikeways by the California Department of Transportation (Caltrans) – bicycle boulevards and cycle tracks. These two facility types will serve as demonstration projects to study their potential to provide greater safety and comfort to bicyclists.

¹ Complete streets are designed and operated to enable safe access for all users. Pedestrians, bicyclists, motorists, and public transportation users of all ages and abilities are able to safely move along and across a complete street. – www.completestreets.org

The network selection and classification process included a public outreach program, on-going consultation with the SANDAG Bicycle-Pedestrian Working Group (BPWG), which is comprised of staff members from each of the 19 local jurisdictions, as well as mapping and modeling to refine the network and proposed bicycle facilities. To enhance the utility of the regional bicycle network, this Plan also includes provisions for secure and convenient bicycle parking and support facilities that encourage transportation-based bicycle trips, and enhance access to transit.

Recommended Programs

The Plan describes five categories of bicycle-related programs that are essential facets of the overall bicycle system envisioned for the San Diego region: education, marketing/public awareness programs, encouragement, enforcement, and on-going monitoring. A spectrum of programs is recommended for consideration that will require regional coordination to successfully implement. Recommended programs include a Complete Streets education program, Safe Routes to School programs, a Pilot Smart Trips Program, expanded Bike to Work Month activities, a route identification and way-finding signage program, and an annual bicycling evaluation program.

1 Introduction

The San Diego Regional Bicycle Plan (Plan) supports implementation of both the Regional Comprehensive Plan (RCP) and Regional Transportation Plan (RTP). The RCP calls for more transportation options and a balanced regional transportation system to support smart growth and a more sustainable region. A policy objective of the RCP is to “create more walkable and bicycle-friendly communities consistent with good urban design concepts.” The RTP calls for a multimodal regional transportation network that includes a regional bicycle network. According to the RTP, “steps to reduce peak-period travel or change when and how people travel will become increasingly important in the future.” To achieve these objectives the Plan sets forth a vision for a distinctive regional bicycle system comprised of interconnected bicycle corridors, support facilities, and programs to make bicycling more practical and desirable to a greater number of the region’s residents and visitors. This vision is intended to guide the future development of the regional bicycle system through the year 2050, congruent with the forthcoming 2050 RTP.

The Plan was developed by evaluating the current regional corridor network and programs to identify opportunities and constraints to bicycling in the San Diego region. Policies to improve bicycling and to recommend a system of safe, convenient, regionally significant bicycle facilities, including standard bikeways, innovative facilities such as bicycle boulevards, bicycle parking, and programs such as an annual evaluation program, are included in the Plan. Recent local and regional bicycling questionnaires have found that residents are willing to bicycle more frequently when better bicycle facilities, support facilities and bicycle-related programs are provided². In Portland, Oregon, bicycle commuting doubled between 1990 and 2000, coinciding with a 215 percent increase in the development of its bicycle network.³

The Plan outlines the necessary steps for a phased implementation strategy where the prioritization of projects and detailed financing options will be undertaken in a subsequent effort that coincides with the development of the 2050 RTP. Additionally, since bicycle transportation plays a role in public health, reducing vehicle miles traveled (VMT), improving air quality, and lessening the dependence on motor vehicle travel, the results of the Plan will be incorporated into the 2050 RTP.

²San Diego Regional Bicycle Plan Survey Results; City of San Diego Bicycle Master Plan Update Bicycle Survey Results, 2009.

³Birk, M. and Geller, R. Bridging the Gaps: How the Quality and Quantity of a Connected Bikeway Network Correlates with Increasing Bicycle Use. TRB Annual Meeting, 2006.

1.1 Setting

The 19 local jurisdictions in the San Diego region encompass approximately 4,300 square miles of varied physical conditions. The region's bays, lagoons, rivers, hills, and mountains help make San Diego a unique and distinctive region but also present challenges for bicycle travel.

In 2009, the San Diego region was home to approximately 3.2 million people, representing a 12.8 percent increase in population since the 2000 Census.⁴ The region's population has been characterized by a relatively steady growth rate since the 1990s; it is also becoming more ethnically diverse. The region's population is expected to grow relatively older, with an anticipated growth rate of 128 percent in the population segment over 65 years by the year 2030.

Table 1-1 shows the distribution of land use types across the region, with roughly 12 percent residential and less than 1 percent commercial and industrial. The largest portions of the county are parks and recreation land and undeveloped, and which includes roadway rights-of-way and rail rights-of-way. Figure 1-1 presents existing land uses across the region.

Table 1.1
Existing Regional Land Uses

Land Use Type	Acreage	Percent of Total
Residential	335,547	12.3%
Commercial & Office	17,538	0.6%
Industrial	14,977	0.5%
Public Facilities & Utilities	188,547	6.9%
Parks & Recreation	1,059,820	38.9%
Agriculture	121,793	4.5%
Undeveloped	984,180	36.1%
Other	4,897	0.2%
TOTALS	2,727,299	100%

*Source: SANDAG Land Use shapefile, 2008; Alta Planning + Design,
April 2009*

⁴ SANDAG, Current Estimates, 2009.

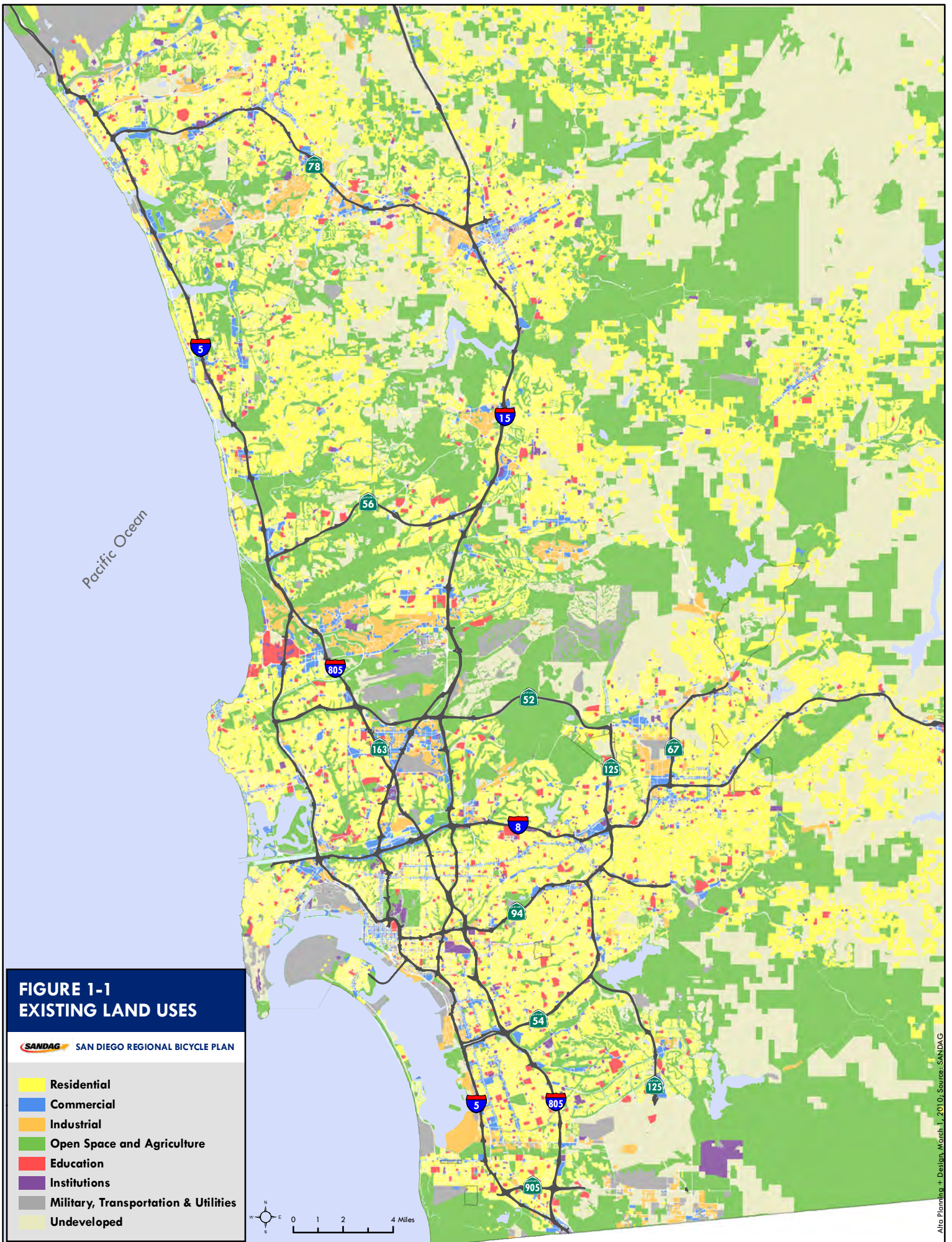

**FIGURE 1-1
EXISTING LAND USES**

SANDAG SAN DIEGO REGIONAL BICYCLE PLAN

- Residential
- Commercial
- Industrial
- Open Space and Agriculture
- Education
- Institutions
- Military, Transportation & Utilities
- Undeveloped

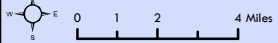

1.2 Benefits of Being a Bicycle Friendly Region

Planning to create a more bicycle friendly region contributes to resolving several complex and interrelated issues, including, traffic congestion, air quality, climate change, public health, and livability. By guiding the region toward bicycle friendly development, this plan can affect all of these issue areas, which collectively can have a profound influence on the existing and future quality of life in the San Diego region.

1.2.1 Environmental/Climate Change Benefits

Replacing vehicular trips with bicycle trips has a measurable impact on reducing human-generated greenhouse gases (GHGs) in the atmosphere that contribute to climate change. Fewer vehicle trips and vehicle miles traveled (VMT) translates into fewer mobile source pollutants, such as carbon dioxide, nitrogen oxides and hydrocarbons, being released into the air. Ground-level ozone, a byproduct of hydrocarbon emissions, has historically been San Diego County's greatest air pollution problem. San Diego County exceeds the State and Federal eight-hour ozone level limits, which also has implications for the population's respiratory and cardiovascular health⁵. While the region has made progress on reducing ozone and other air pollutants, providing transportation options that reduce VMT is an important component of decreasing greenhouse gas emissions and improving the region's air quality. Chapter five of the Plan presents a quantitative estimate of the potential air quality benefits that will result from increased bicycling activity associated with Plan implementation.

1.2.2 Public Health Benefits

Public health professionals have become increasingly aware that the impacts of automobiles on public health extend far beyond asthma and other respiratory conditions caused by air pollution. There is a much deeper understanding of the connection between the lack of physical activity resulting from auto-oriented community designs and various health-related problems such as obesity and other chronic diseases. Although diet and genetic predisposition contribute to these conditions, physical inactivity is now widely understood to play a significant role in the most common chronic diseases in the US, including heart disease, stroke and diabetes – each of which is a leading cause of death in San Diego County. In 2006, 25 percent of all deaths in San Diego County were caused by heart disease.

⁵ Air Quality in San Diego County: 2007 Annual Report. County of San Diego Air Pollution Control District, 2008.

Stroke and diabetes were responsible for an additional nine percent of deaths during that year.⁶

Physical inactivity is a primary contributor to obesity, a health concern that can also lead to other chronic diseases such as heart disease and diabetes. In response to these issues, the public health profession has begun to advocate for the creation of bicycle friendly communities as one of several effective ways to encourage active lifestyles. As the region becomes more conducive to bicycling, the region's population will have more opportunities to exercise, ideally resulting in a higher proportion of the region's residents achieving recommended activity levels.

In addition to individual health benefits, fiscal benefits reward the entire community through a reduction in health care costs and lost days of work. A 2004 study found that every \$1 invested in constructing multi-use paths returns \$2.94 in direct medical benefits.⁷

1.2.3 Economic Benefits

Bicycling is economically advantageous to individuals and communities. According to some statistics, the annual operating costs for bicycle commuters are 1.5% to 3.5% of those for automobile commuters.⁸ Cost savings associated with bicycle travel expenses are also accompanied by potential savings in health care costs. On a community scale, bicycle infrastructure projects are generally far less expensive than automobile-related infrastructure. Further, shifting a greater share of daily trips to bike trips reduces the impact on the region's transportation system, thus reducing the need for improvements and expansion projects. Studies have also shown that the overall contribution of bicycling to the economy is significant. A study conducted by the Wisconsin Department of Transportation and Bicycle Federation of Wisconsin estimates that the bicycle-related sector contributes \$556 million to the economy annually. This estimate does not include the economic benefits derived from bicycle tourism, which is reported to constitute a significant portion of the state's \$11.7 billion in the tourism sector.⁹ The value of the bicycle-related economy in Portland, Oregon is estimated to be \$90 million, representing a 38 percent increase since 2006.¹⁰

⁶ California Department of Public Health, Center for Health Statistics, *Death Statistical Master Files*, 2008.

⁷ Wang, Guijing, et al. 2005. Cost-Benefit Analysis of Physical Activity Using Bike/Pedestrian Trails. *Health Promotion Practice*, Vol. 6, No. 2: 174-179.

⁸ Active Transportation website: <http://www.activetransportation.org/costs.htm>

⁹ *The Economic Impact of Bicycling in Wisconsin*. Wisconsin DOT and the Bicycle Federation of Wisconsin. 2005.

¹⁰ *The Value of the Bicycle-Related Industry in Portland*. Alta Planning + Design. 2008.

1.2.4 Community/Quality of Life Benefits

Fostering conditions where bicycling is accepted and encouraged increases a city's livability from a number of different perspectives, that are often difficult to measure but nevertheless important. The design, land use patterns and transportation systems that comprise the built environment have a profound impact on quality of life issues. Studies have found that people living in communities with built environments that promote bicycling and walking tend to be more socially active, civically engaged, and are more likely to know their neighbors; whereas urban sprawl has been correlated with social and mental health problems, including stress.^{11 12} Settings where walking and riding bicycles are viable also offer greater independence to elderly people who are unable to drive automobiles. The aesthetic quality of a community also improves when visual and noise pollution caused by automobiles is reduced and when green space is reserved for facilities that enable people of all ages to recreate and commute in pleasant settings.

1.2.5 Safety Benefits

Conflicts between bicyclists and motorists result from poor riding and/or driving behavior as well as insufficient or ineffective facility design. Encouraging development and redevelopment in which bicycle travel is fostered improves the overall safety of the roadway environment for all users. Well-designed bicycle facilities improve security for current cyclists and also encourage more people to bike, which in turn, can further improve bicycling safety. Studies have shown that the frequency of bicycle collisions has an inverse relationship to bicycling rates – more people on bicycles equates to fewer crashes.¹³ Providing information and educational opportunities about safe and lawful interactions between bicyclists and other roadway users likewise enhances safety.

1.3 Role of the Regional Bicycle Plan

The Plan is a complementary document to the existing 2030 RTP, the transportation component of the RCP and will be fully integrated into the 2050 RTP currently under development. The RCP establishes a vision for transportation in the region. A part of this vision is a transportation system that makes walking, biking and using transit more convenient and desirable

¹¹ Frumkin, H. 2002. Urban Sprawl and Public Health. *Public Health Reports* 117: 201–17.

¹² Leyden, K. 2003. Social Capital and the Built Environment: The Importance of Walkable Neighborhoods. *American Journal of Public Health* 93: 1546–51.

¹³ Jacobsen, P. Safety in Numbers: More Walkers and Bicyclists, Safer Walking and Bicycling. *Injury Prevention*, 9: 205-209. 2003.

options. The Plan provides a long-range blueprint to advance the bicycling component of this vision.

The Plan contains goals and recommendations that are regional in scope and provides a planning framework to guide decision-making. As a large and complex region where many trips are inter-jurisdictional, the San Diego region requires a complete and integrated network of bikeways and support facilities to increase bicycling trips. While bicycle planning and policy-making is primarily focused on the local level, the development of the Plan provides an opportunity to improve regional coordination and connectivity of bicycle facilities between jurisdictions. The Plan also provides guidance to local decision-makers on the design of bicycle facilities, development of programs, and prioritization of improvement projects.

1.4 Major Recommendations of the Plan

This plan outlines a range of recommendations to facilitate accomplishing the regional goals of increasing the number of people who bike and frequency of bicycle trips for all purposes, encouraging the development of Complete Streets¹⁴, improving safety for bicyclists, and increasing public awareness and support for bicycling in the San Diego region. The recommendations include bicycle infrastructure improvements, bicycle-related programs, implementation strategies, and policy and design guidelines. Key recommendations are outlined below.

1.4.1 Bicycle Infrastructure Improvements

The Plan presents an interconnected network of bicycle corridors that would enable residents to bicycle with greater safety, directness, and convenience within and between major regional destinations and activity centers. The regional network consists of a combination of standard bicycle facilities, including Class I bike paths, Class II bike lanes, and Class III bike routes which are described and depicted in greater detail in Table 3.3. The Plan also proposes two facility types that are not defined as bikeways by the California Department of Transportation (Caltrans) – bicycle boulevards and cycle tracks. These two facility types will serve as demonstration projects to study their potential to provide greater safety and comfort to bicyclists.

The regional bicycle network is one of two bicycle network alternatives developed to reflect varying future funding scenarios. The preferred regional bicycle network is based on region-wide bicycle system need

¹⁴ Complete streets are designed and operated to enable safe access for all users. Pedestrians, bicyclists, motorists, and public transportation users of all ages and abilities are able to safely move along and across a complete street. – www.completestreets.org

without consideration of short-term fiscal constraints. The alternative “revenue constrained network” assumes a funding scenario in which only currently known federal, state, and local transportation revenues are available, supplemented with additional resources that are anticipated to become available through 2030. The network alignments associated with each funding scenario are identical. The difference in cost between the two networks is dependent upon the specific proportion of facility types that comprise a corridor. For example, a particular regional corridor may include Class I bike paths along several segments under the regional bicycle network, and Class II bike lanes along the same segments under the revenue constrained scenario. In summary, the amount of Class I facilities is the single most influential factor in determining the overall cost of each network scenario.

The alternative network unconstrained by 2030 financial conditions was selected as the regional bicycle network for three principal reasons: 1) the regional bicycle network accurately reflects bicycle system needs and is consistent with direction from policy makers and citizen input showing a preference for facilities separate from the roadway, whereas the revenue constrained network underestimates need; 2) the regional bicycle network provides a blueprint for developing a comprehensive regional bikeway system to be complete in 2050 corresponding with the 2050 RTP; and 3) acknowledging the region’s actual bicycle system needs broadens the scope of funding opportunities to pursue for system development. The regional bicycle network is described in greater detail in Chapter 3.

The network selection and classification process included a public outreach program, on-going consultation with the SANDAG Bicycle-Pedestrian Working Group (BPWG), which is comprised of staff members from each of the 19 local jurisdictions, as well as mapping and modeling to refine the network and proposed bicycle facilities. To enhance the utility of the regional bicycle network, this Plan also includes provisions for secure and convenient bicycle parking and support facilities that encourage transportation based bicycle trips, and access to transit.

1.4.2 Recommended Programs

The Plan describes five categories of bicycle-related programs that are essential facets of the overall bicycle system envisioned for the San Diego region: education, marketing/public awareness programs, encouragement, enforcement, and on-going monitoring. Chapter 4 provides an overview of these program types as well as synopses of representative programs within each category. These recommended programs were identified through an assessment of the region’s program deficiencies and needs determined through extensive public outreach, direction from the BPWG, comparisons

with national model programs, and an analysis of the probable effectiveness of each program within the San Diego context.

1.5 Overview of the Plan Contents

After this introductory chapter, the Plan is organized into the following chapters:

Chapter 2 describes the goals, objectives, and policy actions that provide a vision for future bicycling in the region and serve as the foundation for the Plan recommendations.

Chapter 3 presents a vision of a regional bicycle system, including a classified bicycle network and support facilities.

Chapter 4 summarizes bicycle-related program types recommended for the region.

Chapter 5 provides estimates of the benefits of the proposed regional bicycle network in terms of reduction in GHG.

Chapter 6 addresses an implementation strategy and potential financing options.

Chapter 7 presents bicycle facility design guidelines and a best practices manual to serve as a guide for planners, engineers, and designers.

2 Goals, Objectives, and Policy Actions

This chapter outlines the goals and objectives that will serve as guidelines in the development of the regional bicycle network and programs and that articulate a vision of an ideal future bicycling environment in the San Diego region. The Plan goals and objectives are derived from the RCP and 2030 RTP and were refined based on information garnered over the course of this planning process, including public involvement, and input from the SANDAG Bicycle-Pedestrian Working Group (BPWG) and SANDAG staff.

The RCP seeks to balance regional population, housing, and employment growth with habitat preservation, agriculture, open space, and infrastructure needs. A part of the vision supported by the RCP is a transportation system that makes walking, biking, and transit desirable and reasonable options. A related objective stated in the RCP is to create more bicycle-friendly and walkable communities consistent with good urban design principles. The RCP also recommends enhancing pedestrian and bicycle connections to transit as one action that would help improve the regional transportation system.

2.1 Goals

The goals of the Regional Bicycle Plan describe the guiding principles and long-range vision for the region's bicycling environment.

Goal 1: Significantly Increase Levels of Bicycling throughout the San Diego Region

Increase bicycling by all types of bicycle riders for all trip purposes through consistent support of programs and infrastructure projects that address the five Es: Education, Encouragement, Enforcement, Engineering, and Evaluation.

Goal 2: Improve Bicycling Safety

Improve bicycling safety by increasing education and training opportunities for cyclists, pedestrians, motorists, and professionals whose work impacts the roadway environment, and by promoting enforcement of traffic laws to reduce bicycle related conflicts.

Goal 3: Encourage the Development of Complete Streets

Promote the integration of Complete Streets principles into roadway planning, design, and maintenance policies so that all roadways safely accommodate all users, including bicyclists, pedestrians, transit riders, children, older people, and disabled people, as well as motorists.

Goal 4: Support Reductions in Greenhouse Gas Emissions

Support the integration of bicycle related policies and infrastructure improvements that lead to VMT reduction by converting a higher share of total intra and intercommunity trips to bicycle trips.

Goal 5: Increase Community Support for Bicycling

Increase community support for bicycling by supporting programs that raise public awareness about bicycling and encourage more people to bicycle.

2.2 Objectives and Policy Actions

These objectives are the intermediary steps toward attaining the goals of the Plan. The policy actions describe how policy makers and other decision makers will implement the stated objectives.

Objective 1: Improve the connectivity and quality of the regional bicycle network.

Recommended Policy Actions:

- Support bicycle improvement projects that close gaps in the regional bicycle network either by implementing specific projects recommended in the Plan or through other treatments.
- Encourage local government bicycle projects that connect local facilities to the regional bicycle corridors.
- Promote consistent signage that directs bicyclists to destinations and increases the visibility of the regional bicycle network.

Objective 2: Provide policy direction and funding to assist local jurisdictions with bicycle planning and project implementation.

Recommended Policy Actions:

- Update the Plan as needed and in coordination with Regional Transportation Plan updates to provide continued direction, chart progress, and to respond to changing circumstances.
- Through the SANDAG Bicycle-Pedestrian Working Group, provide continued guidance on the use of bicycle-friendly designs and innovative treatments through updates to the bicycle design guidelines published in conjunction with the Plan and through other means of communication with local jurisdictions.
- Encourage reallocation of roadway rights-of-way where appropriate to accommodate bicycling and bicycle facilities.

- Promote the preservation of bicycle access within all roadway rights-of-way, as well as the development of innovative, safety-enhanced on-street facilities, such as bicycle boulevards.
- Continue the *TransNet* and Transportation Development Act (TDA) funding programs that direct funds to local governments to improve and expand bicycle facilities and programs throughout the San Diego region.
- In support of Board Policy No. 031, *TransNet* Ordinance and Expenditure Plan Rules, Rule #21: Accommodation of Bicyclists and Pedestrians, continue to mandate bicycle travel accommodations of all projects funded with *TransNet* revenue. Establish a monitoring program to measure the effectiveness and benefits of the Rule.
- Establish a program and implementation plan for local governments to conduct bicycle counts and assessments when any local land development requires a traffic impact study.

Objective 3: Support bicycle-transit integration to improve access to major employment and other activity centers and to encourage multimodal travel for longer trip distances.

Recommended Policy Actions:

- Develop regional on-demand bike lockers that are accessible using a fare payment card that allows users to access a variety of transit modes administered by multiple agencies.
- Support the development of bicycle facilities that provide access to regional and local public transit services wherever possible.
- Coordinate with transit providers to ensure bicycles can be accommodated on all forms of transit vehicles and that adequate space is devoted to their storage on board whenever possible.
- Coordinate with transit agencies to install and maintain convenient and secure short-term and long-term bike parking facilities – racks, on-demand bike lockers, in-station bike storage, and staffed bicycle parking facilities – at transit stops, stations, and terminals.
- Work with local jurisdictions to facilitate bicycle-friendly development activity and support facilities, such as bicycle rental and repair, around transit stations.
- Provide current and relevant information to cyclists regarding bike parking opportunities located at transit stations through a variety of formats, such as the SANDAG website and regional bike maps.

Objective 4: Ensure the provision of convenient and secure bicycle parking and support facilities region-wide.

Recommended Policy Actions:

- Prepare recommended bicycle parking standards that provide context sensitive solutions for the location and number of spaces that should be provided.
- Encourage local jurisdictions to install and support short-term, long-term, and high capacity bicycle parking within the public right-of-way and on public property.
- Encourage local jurisdictions to adopt bicycle parking ordinances.
- Encourage local jurisdictions to create policies or programs that incentivize building owners and employers to provide showers and clothing lockers along with secure bike parking in areas where employment density warrants.
- Provide current and relevant information to cyclists regarding bike parking opportunities throughout the region through a variety of formats.
- Consider a bike sharing program with distribution stations located in major employment and other activity centers throughout the region.

Objective 5: Institutionalize Complete Streets principles in roadway planning, design, and maintenance policies.

Recommended Policy Actions:

- Provide Complete Streets training to transportation-related professionals.
- Consider development of a region-wide Complete Streets policy and guidelines manual.
- Encourage local jurisdictions to adopt a Complete Streets policy to be included in their General Plans.

Objective 6: Increase education, encouragement, enforcement, and performance monitoring and evaluation programs.

Recommended Policy Actions:

- Support programs that educate the bicycling and general public about bicycle operation, bicyclists' rights and responsibilities, and lawful interactions between motorists and cyclists.

- Support marketing and public awareness campaigns aimed at promoting bicycling and/or improving safety.
- Support enhancements to Bike to Work Month promotional activities and events.
- Monitor and evaluate the San Diego region's bicycling efforts by implementing a regional annual evaluation program that includes: collecting bicycle and pedestrian count data; conducting a regional non-motorized travel survey; and generating an annual report on the state of non-motorized transportation in the region.
- Support programs aimed at increasing bicycle trips by providing incentives, recognition, or services that make bicycling a more convenient transportation mode.
- Encourage enforcement efforts that target unsafe bicyclist and motorist behaviors and enforce laws that reduce bicycle/motor vehicle collisions and conflicts.
- Encourage local jurisdictions to monitor and evaluate progress toward becoming bicycle-friendly by establishing advisory committees, staffing bicycle coordinator positions and by evaluating bicycle master plan implementation.

3 Recommended Regional Bicycle Network

A primary objective of the Plan is to improve the connectivity and quality of the regional bicycle network and bicycle support facilities. Defining and improving a comprehensive regional bicycle network is essential to meeting the 2030 RTP goals of options that help alleviate future traffic demands and congestion. The Plan is regional in focus and provides a framework to promote consistency between and among local jurisdictions and encourage the development of quality facilities region wide. The current regional system requires additional on- and off-street bicycle facilities, safety improvements, improved connections to transit facilities and corridor realignments to enable bicyclists to reach key destinations and encourage more people to bicycle more frequently.

As described in the 2030 RTP,

“The goal of the [Regional Bicycle Plan] is to encourage the development of a unified bicycle system throughout the San Diego region that serves the needs of people using their bicycle for transportation and recreational bicyclists with connections to local and regional activity centers and transit facilities and other regional non-motorized systems.”

This chapter describes the infrastructure-related components of the regional bicycle system and is organized into the following sections:

- Existing Bikeways
- Regional Bikeways in the 2030 RTP
- Network Planning Process
- Regional Corridor Classifications
- Regional Bicycle Network
- Regional Bicycle Parking

The regional bicycle network presented in this chapter is a vital component of the overall regional bicycle system vision, which also includes distinctive bicycle programs and support facilities.

3.1 Existing Bikeways

SANDAG publishes a bike map showing existing bicycle facilities in the region, as well as other recommended routes. **Table 3.1** summarizes mileage of bikeways by facility type for the entire region, including those facilities designated as regional corridors. **Figure 3-1** displays all existing local and regional bikeways across the region.

Table 3.1
Existing Bicycle Facilities in the Region

Facility Type	Miles	% of Total
Class I – Path	159.3	11.9%
Class II – Lane	890.2	66.4%
Class III – Route	243.9	18.2%
Freeway Shoulders	47.4	3.5%
TOTALS	1,340.8	100%

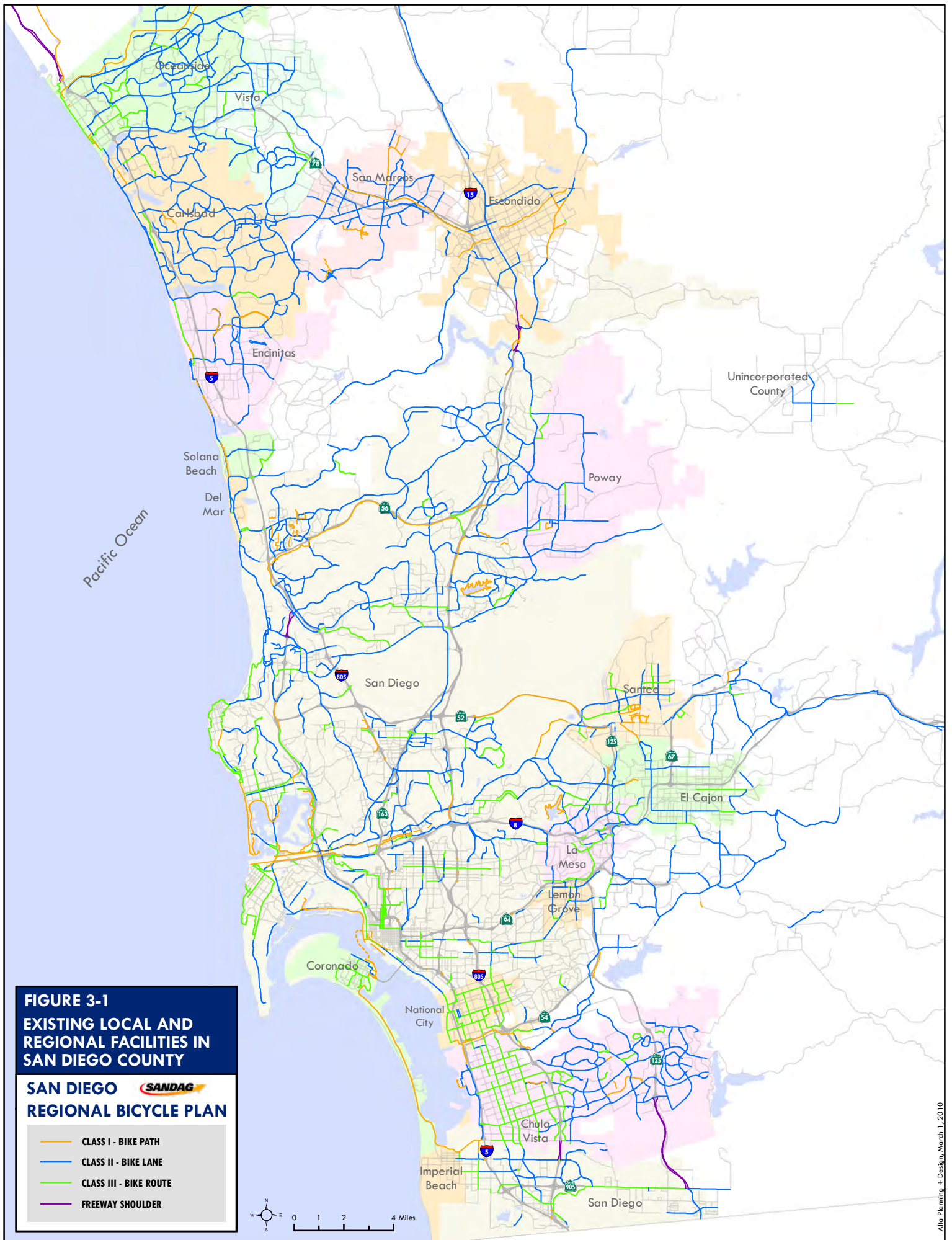

Source: SANDAG Bikes shapefile, 2010; Alta Planning + Design, April, 2010

There are approximately 1,340 miles of existing bikeway facilities in the region. Class II facilities are the predominate type of bikeway at roughly 66 percent of the total, followed by Class III facilities at 18 percent of the regional total. Class I facilities comprise about 12 percent of the regional total. Although bicycles are allowed on a few select freeway shoulders, this Plan does not propose to include those facilities in the regional bicycle network as they are not intended to accommodate users of all types.



**FIGURE 3-1
EXISTING LOCAL AND
REGIONAL FACILITIES IN
SAN DIEGO COUNTY**

SAN DIEGO 
REGIONAL BICYCLE PLAN

-  CLASS I - BIKE PATH
-  CLASS II - BIKE LANE
-  CLASS III - BIKE ROUTE
-  FREEWAY SHOULDER

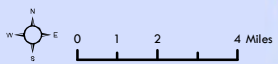

Table 3.2 presents a summary of existing bikeways by facility type and jurisdiction. Six local jurisdictions – Del Mar, Imperial Beach, La Mesa, Lemon Grove, Poway, and Vista – have one mile or less of Class I facilities; while Imperial Beach and National City are the only jurisdictions with one mile or less of Class II facilities.

Table 3.2
Existing Bicycle Facilities by Jurisdiction

Jurisdiction	Mileage by Facility Type				Total Mileage by Jurisdiction	Percent of Regional Total Mileage	Percent of Regional Population
	Class I	Class II	Class III	Freeway Shoulder			
Carlsbad	4.2	85.6	4.9	0	94.7	7.06%	3.3%
Chula Vista	6.0	67.1	42.6	5.3	121	9.02%	7.4%
Coronado	9.6	1.5	5.0	0	16.1	1.20%	0.7%
Del Mar	0.1	6.0	0.2	0	6.3	0.47%	0.1%
El Cajon	1.3	14.8	3.5	0	19.6	1.46%	3.1%
Encinitas	4.4	21.1	3.0	0	28.5	2.13%	2.0%
Escondido	10.2	33.0	0.1	1.8	45.1	3.36%	4.6%
Imperial Beach	0.6	0.2	0.3	0	1.1	0.08%	0.9%
La Mesa	0.0	13.0	10.5	0	23.5	1.75%	1.8%
Lemon Grove	0.0	7.8	1.0	0	8.8	0.66%	0.8%
National City	2.5	1.0	20.4	0	23.9	1.78%	2.0%
Oceanside	8.8	81.0	16.4	0	106.2	7.92%	5.7%
Poway	0.7	27.0	3.2	0	30.9	2.31%	1.6%
San Diego	71.6	308.4	112.9	16.1	509	37.96%	42.5%
San Marcos	11.8	45.3	0.0	0	57.1	4.26%	2.6%
Santee	7.7	13.7	8.1	0	29.5	2.20%	1.8%
Solana Beach	1.6	3.6	1.4	0	6.6	0.50%	0.4%
Vista	0.0	23.5	4.6	0	28.1	2.10%	3.1%
Unincorporated	18.2	136.6	5.8	24.2	184.8	13.78%	15.5%
TOTALS	159.3	890.2	243.9	47.4	1,340.8	100%	100%

Source: SANDAG Bikes shapefile, 2010; Alta Planning + Design, April 2010

As shown in Table 3.2, the City of San Diego has the greatest percentage of facilities that are also part of the regional bicycle network, at roughly 38 percent of the regionwide total, while Imperial Beach, Del Mar, and Solana Beach have the smallest percentage of the regional total, respectively. The overall trends in bikeway facility provision follow trends in population and land area. There are eight jurisdictions whose share of regional bicycle facilities is less than their share of the regional population. These jurisdictions include El Cajon, Escondido, Imperial Beach, Lemon Grove, National City, San Diego, Vista, and the unincorporated county.

3.2 Regional Bikeways in the 2030 RTP

The regional bicycle network as proposed in the 2030 RTP consists of a total of 445 miles of existing and planned facility. The 2030 RTP does not define the classification for each of the segments in the regional corridor system. Figure 3-2 displays an overview of the adopted regional corridors from the 2030 RTP, which served as the starting point for the development of the regional bicycle network.

3.3 Network Planning Process

Development of the Plan required close examination of the network and alignments in the 2030 RTP. The network planning process included public input, consultation with the SANDAG Bicycle-Pedestrian Working Group (BPWG) comprised of staff members from each of the 19 local jurisdictions, and GIS mapping and modeling to refine the proposed network alignments and facility classifications.

Criteria adopted by the SANDAG Transportation Committee were employed in refining an updated regional bicycle network, including serving the highest relative bicycle demands across the region, providing for the most direct connections, and incorporating existing facilities where feasible (A complete presentation of the existing conditions analysis documenting this background assessment is presented in Appendix A.). Figure 3-3 presents a regionwide overview of the updated regional bicycle network adopted by the Transportation Committee. Proposed changes to the 2030 RTP regional network include the addition of seven new corridors and the adjustment of alignments for eight corridors. Figure 3-4 displays the changes between the 2030 RTP regional network and the updated network for the Plan.

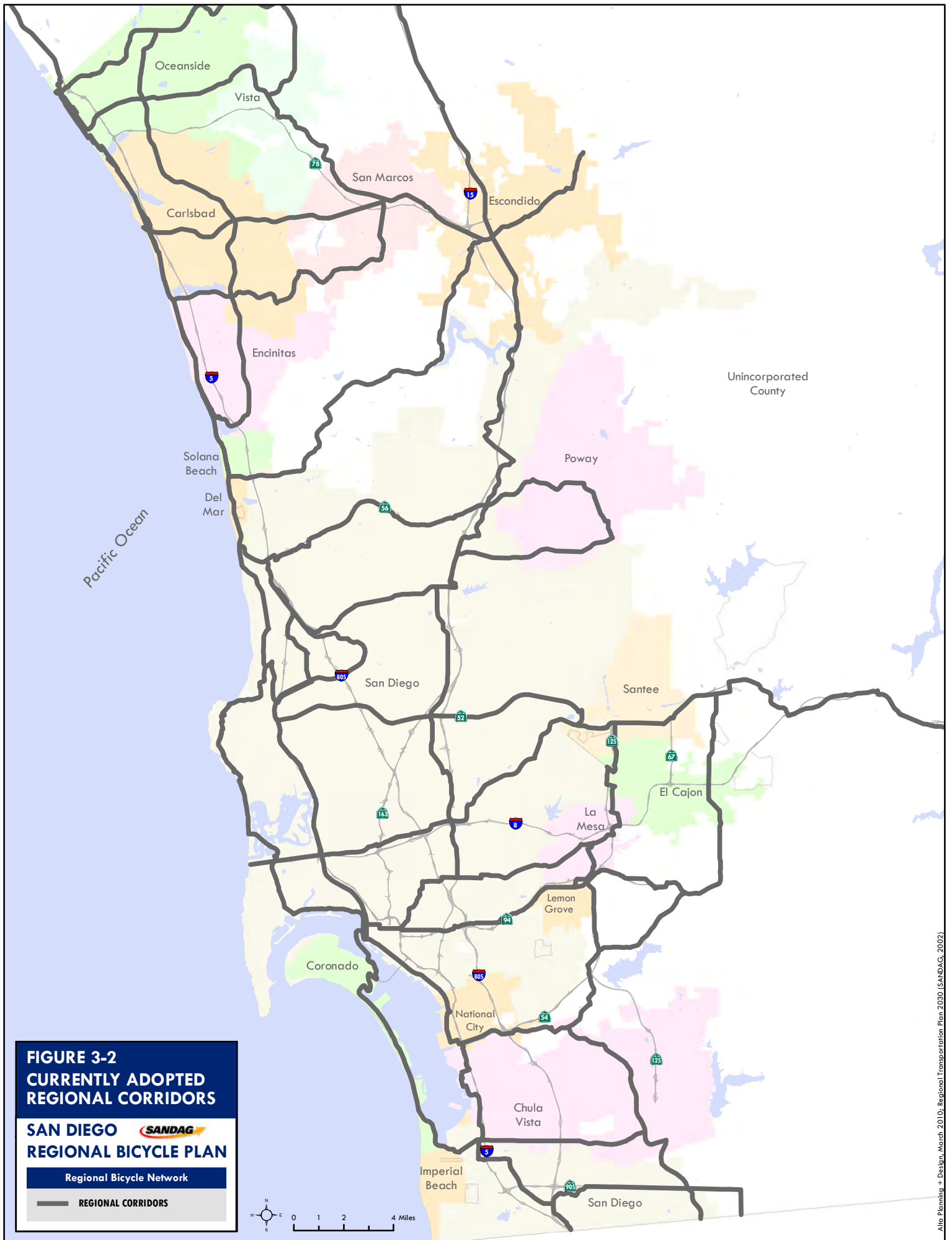

**FIGURE 3-2
CURRENTLY ADOPTED
REGIONAL CORRIDORS**

SAN DIEGO  **REGIONAL BICYCLE PLAN**

Regional Bicycle Network

 REGIONAL CORRIDORS



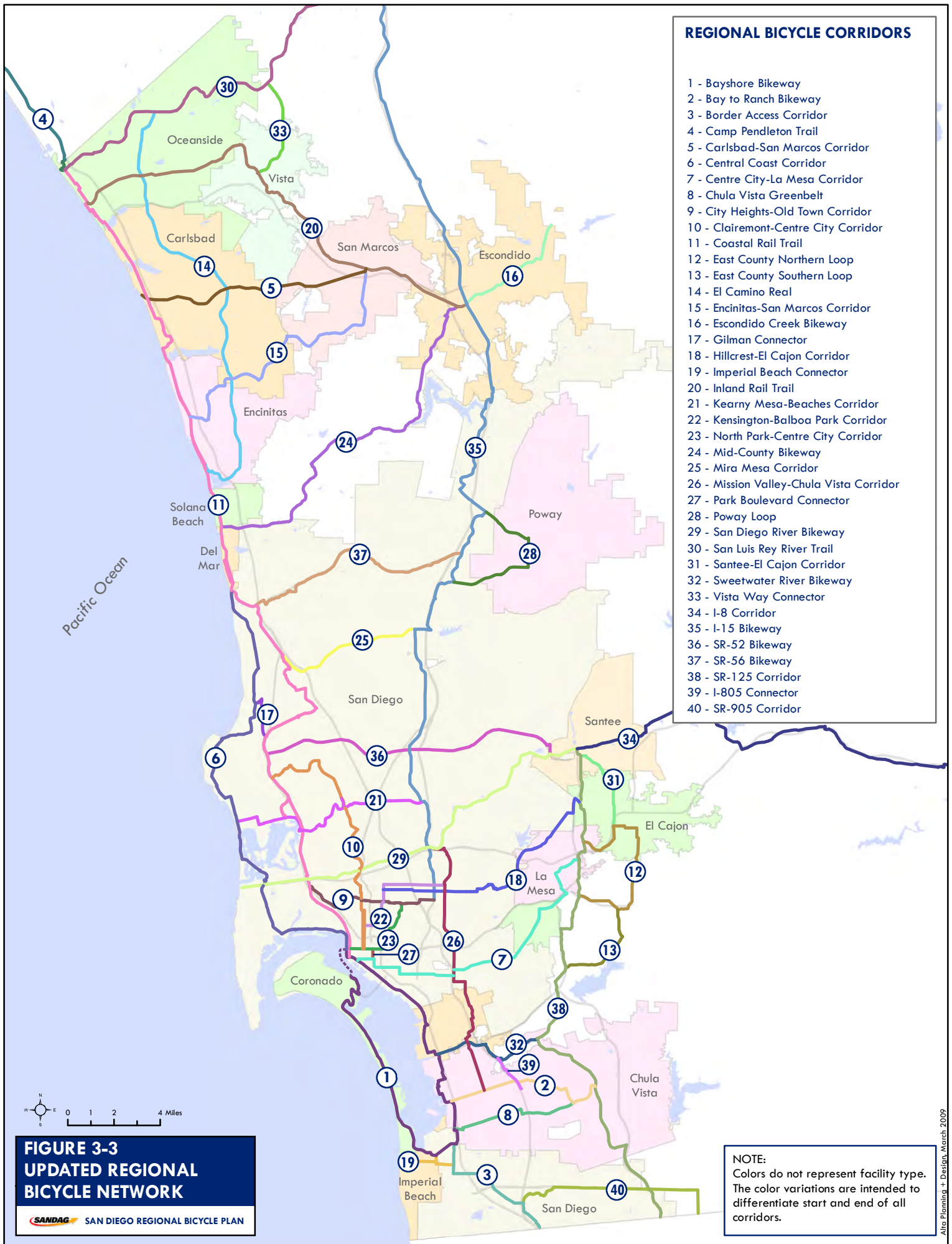

REGIONAL BICYCLE CORRIDORS

- 1 - Bayshore Bikeway
- 2 - Bay to Ranch Bikeway
- 3 - Border Access Corridor
- 4 - Camp Pendleton Trail
- 5 - Carlsbad-San Marcos Corridor
- 6 - Central Coast Corridor
- 7 - Centre City-La Mesa Corridor
- 8 - Chula Vista Greenbelt
- 9 - City Heights-Old Town Corridor
- 10 - Clairemont-Centre City Corridor
- 11 - Coastal Rail Trail
- 12 - East County Northern Loop
- 13 - East County Southern Loop
- 14 - El Camino Real
- 15 - Encinitas-San Marcos Corridor
- 16 - Escondido Creek Bikeway
- 17 - Gilman Connector
- 18 - Hillcrest-El Cajon Corridor
- 19 - Imperial Beach Connector
- 20 - Inland Rail Trail
- 21 - Kearny Mesa-Beaches Corridor
- 22 - Kensington-Balboa Park Corridor
- 23 - North Park-Centre City Corridor
- 24 - Mid-County Bikeway
- 25 - Mira Mesa Corridor
- 26 - Mission Valley-Chula Vista Corridor
- 27 - Park Boulevard Connector
- 28 - Poway Loop
- 29 - San Diego River Bikeway
- 30 - San Luis Rey River Trail
- 31 - Santee-El Cajon Corridor
- 32 - Sweetwater River Bikeway
- 33 - Vista Way Connector
- 34 - I-8 Corridor
- 35 - I-15 Bikeway
- 36 - SR-52 Bikeway
- 37 - SR-56 Bikeway
- 38 - SR-125 Corridor
- 39 - I-805 Connector
- 40 - SR-905 Corridor

FIGURE 3-3
UPDATED REGIONAL
BICYCLE NETWORK
SAN DIEGO REGIONAL BICYCLE PLAN

NOTE:
 Colors do not represent facility type.
 The color variations are intended to
 differentiate start and end of all
 corridors.

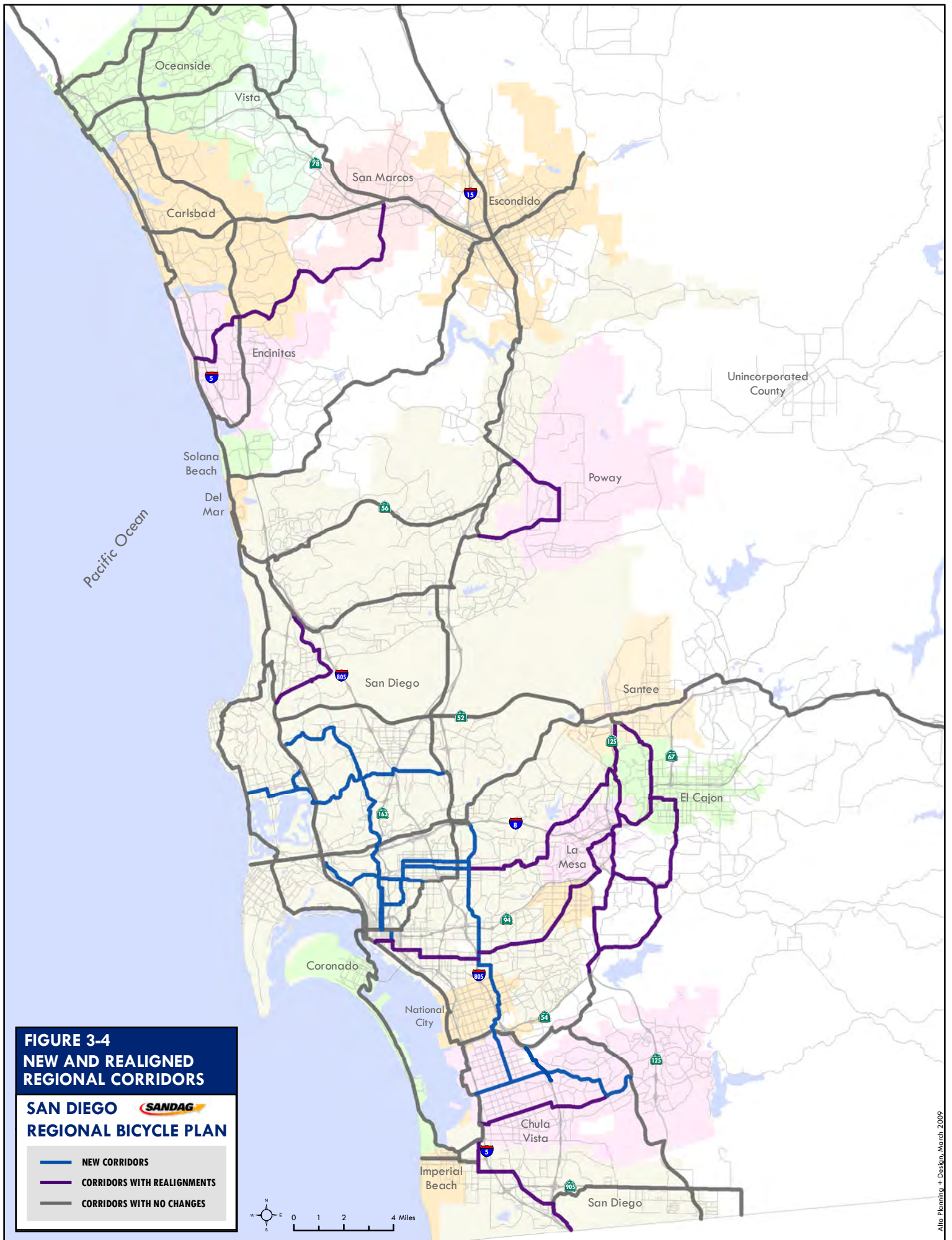

3.4 Regional Corridor Classifications

The same method that informed the network alignment process described in Section 3.3 was utilized to establish a bicycle facilities classification system that was applied to the regional corridor alignments to establish a clear vision for future development of the regional bikeway system. The system included five classification types. Three are from the Caltrans Highway Design Manual (referenced in Chapter 7) bikeway classifications enhanced with additional bicycle facility treatments, such as intersection treatments to improve high bicycle/motorist conflict areas. The Plan also proposes the consideration of two classifications not currently defined by the Highway Design Manual – bicycle boulevards and cycle tracks – to provide additional opportunities for regional bikeway connections. Because cycle tracks include non-standard design elements, the cycle track classification is recommended for limited segments to serve as a pilot project. Table 3-3 displays the classification system employed in planning for the regional bicycle system. Greater detail on the design of standard and non-standard facilities and treatments is provided in Chapter 7. All regional corridors should be identifiable via identification and way-finding signage that names each corridor and allows users to easily understand the destinations served by each respective corridor.

**Table 3.3
Regional Corridor Classification System**



<p>Class I – Bike Path</p> <p>Bike paths are bikeways that are physically separated from vehicular traffic. Also termed shared-use paths, bike paths accommodate bicycle, pedestrian, and other non-motorized travel. Paths can be constructed in roadway right-of-way or independent right-of-way. Bike paths provide critical connections in the region where roadways are absent or are not conducive to bicycle travel.</p>	 <p>The diagram illustrates a Class I Bike Path. The top portion shows a side view with a 10' min vertical clearance indicated by a dashed box. Below this, a path of 8' min width is shown between two 2' wide buffer zones. The bottom portion shows a top-down view of the path with a yellow center line, a blue bicycle symbol, and a black arrow pointing in the direction of travel.</p>
<p>Class II - Bike Lanes</p> <p>Bike lanes are defined by pavement markings and signage used to allocate a portion of a roadway for exclusive or preferential bicycle travel. Within the regional corridor system, bike lanes should be enhanced with treatments that improve safety and connectivity by addressing site-specific issues. Such treatments include innovative signage, intersection treatments, and bicycle loop detectors.</p>	 <p>The diagram illustrates a Class II Bike Lane. The top portion shows a side view with a 10-12' lane width, a 4' stripe on the left, a 6' stripe on the right, and a 5' parking area. A blue car is on the left, a red car is on the right, and a cyclist is in the lane. A 'Bike Lane' sign is visible on the right. The bottom portion shows a top-down view of the lane with a blue car on the left, a red car on the right, a white arrow pointing forward, a black arrow pointing right, and a blue bicycle symbol.</p>
<p>Class III - Bike Routes</p> <p>Bike routes are located on shared roadways that accommodate vehicles and bicycles in the same travel lane. Established by signs, bike routes provide continuity to other bike facilities or designate preferred routes through corridors with high demand. Within the regional corridor system, bike routes should be enhanced with treatments that improve safety and connectivity by addressing site-specific issues.</p>	 <p>The diagram illustrates a Class III Bike Route. The top portion shows a side view with a 14' preferred min lane width and a 'D11-1 Bike Route Sign' on the right. A blue car is on the left, a red car is on the right, and a cyclist is in the lane. The bottom portion shows a top-down view of the lane with a blue car on the left, a red car on the right, and a blue bicycle symbol.</p>

Table 3.3, Continued
Regional Corridor Classification System

<p>Cycle Tracks</p> <p>A cycle track is a hybrid type bicycle facility that combines the experience of a separated path with the on-street infrastructure of a conventional bike lane. Cycle tracks are bikeways located in roadway right-of-way but separated from vehicle lanes by physical barriers or buffers. Cycle tracks provide for one-way bicycle travel in each direction adjacent to vehicular travel lanes and are exclusively for bicycle use. Cycle tracks are not recognized by Caltrans Highway Design Manual as a bikeway facility. Development of cycle track on segments of the regional corridor system is proposed through experimental, pilot projects.</p>	<p>The diagram illustrates a cross-section of a cycle track. On the left is a car lane. To its right is a cycle track, separated by a barrier. The width of the cycle track is labeled as 2'. To the right of the cycle track is a sidewalk, which is 7' wide. The sidewalk contains trees, a street lamp, and pedestrians. Labels indicate 'Sidewalk Furnishings Separate Pedestrians' and 'Bollards, or Other Barrier'.</p>
<p>Bicycle Boulevards</p> <p>Bicycle boulevards are local roads or residential streets that have been enhanced with traffic calming and other treatments to facilitate safe and convenient bicycle travel. Bicycle boulevards accommodate bicyclists and motorists in the same travel lanes, typically without specific vehicle or bicycle lane delineation. These roadway designations prioritize bicycle travel above vehicular travel. The treatments applied to create a bike boulevard heighten motorists' awareness of bicyclists and slow vehicle traffic, making the boulevard more conducive to safe bicycle and pedestrian activity. Bicycle boulevard treatments include signage, pavement markings, intersection treatments, traffic calming measures and can include traffic diversions. Bicycle boulevards are not defined as bikeways by Caltrans Highway Design Manual; however, the basic design features of bicycle boulevards comply with Caltrans standards.</p>	<p>The diagram shows a street layout for a bicycle boulevard. A central vertical street is flanked by a raised median. At an intersection with a horizontal cross-street, there are stop signs on the cross-street. A 'Median opening allows bicyclists to cross arterial'. A 'Raised median prevents motorists from cutting through'. 'Stop signs on cross-streets favor through bicycle movement'. 'Bicycle boulevard signs and pavement markings serve as wayfinding devices and reinforce that bicyclists are on a preferred route'. 'Mini traffic circles and speed humps serve as traffic calming devices'.</p>

3.5 The Regional Bicycle Network

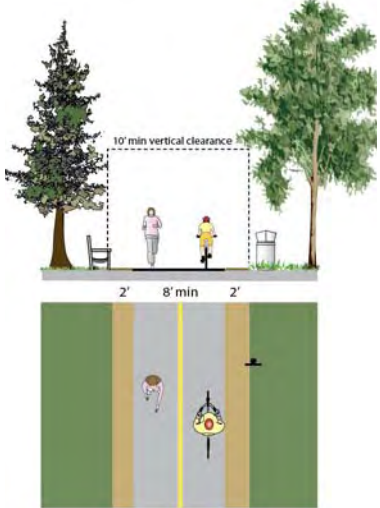
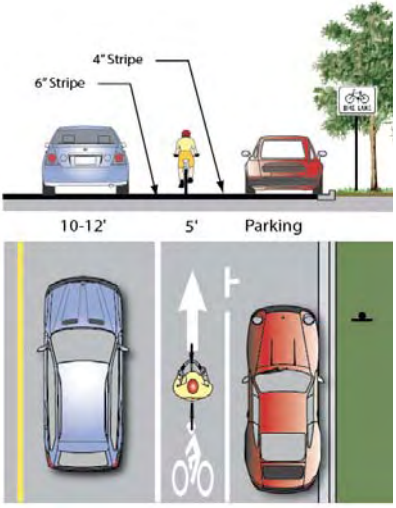
This section presents alignments and classifications for the updated regional bicycle network. The regional bicycle network reflects a comprehensive view of the region’s bikeway system needs and represents the vision for a regional network in the year 2050. As part of the planning effort, two bicycle network alternatives were developed, the preferred regional bicycle network and a revenue constrained network. The revenue constrained network is based on a scenario in which only currently known federal, state, and local transportation revenues, supplemented with resources anticipated to become available through 2030, are available for network construction. Whereas, the preferred regional bicycle network accurately reflects the region’s bikeway needs unconstrained by shorter-term fiscal conditions. Further details on the different revenue scenarios can be found in Chapter 6.

Section 3.3 of this chapter summarizes the process employed to develop the regional bicycle network. Figure 3-5 shows the alignments along with the bicycle facility classifications proposed for each corridor. Figure 3-6 displays existing facilities within the regional corridors along with portions of the regional corridor system that have not been built.

Table 3.4 presents a summary of the regional bicycle network mileage by classification type for each of its 40 corridors. As shown, the network would provide for approximately 515.5 miles of facility, including roughly 227.8 miles of Class I facility, 212.5 miles of enhanced Class II, 33.7 miles of enhanced Class III, 8.3 miles of cycle track, and 34.2 miles of bicycle boulevard.

Table 3.4
Facility Type and Mileage for the Regional Bicycle Network

Facility Type	Mileage	Percent of Total
Class I – Bike Path	227.8	44.2 %
Enhanced Class II – Bike Lane	212.5	41.3 %
Enhanced Class III – Bike Route	32.7	6.3 %
Cycle Track	8.3	1.6 %
Bicycle Boulevard	34.2	6.6 %
TOTALS	515.5	100 %

Source: Alta Planning + Design, April 2009



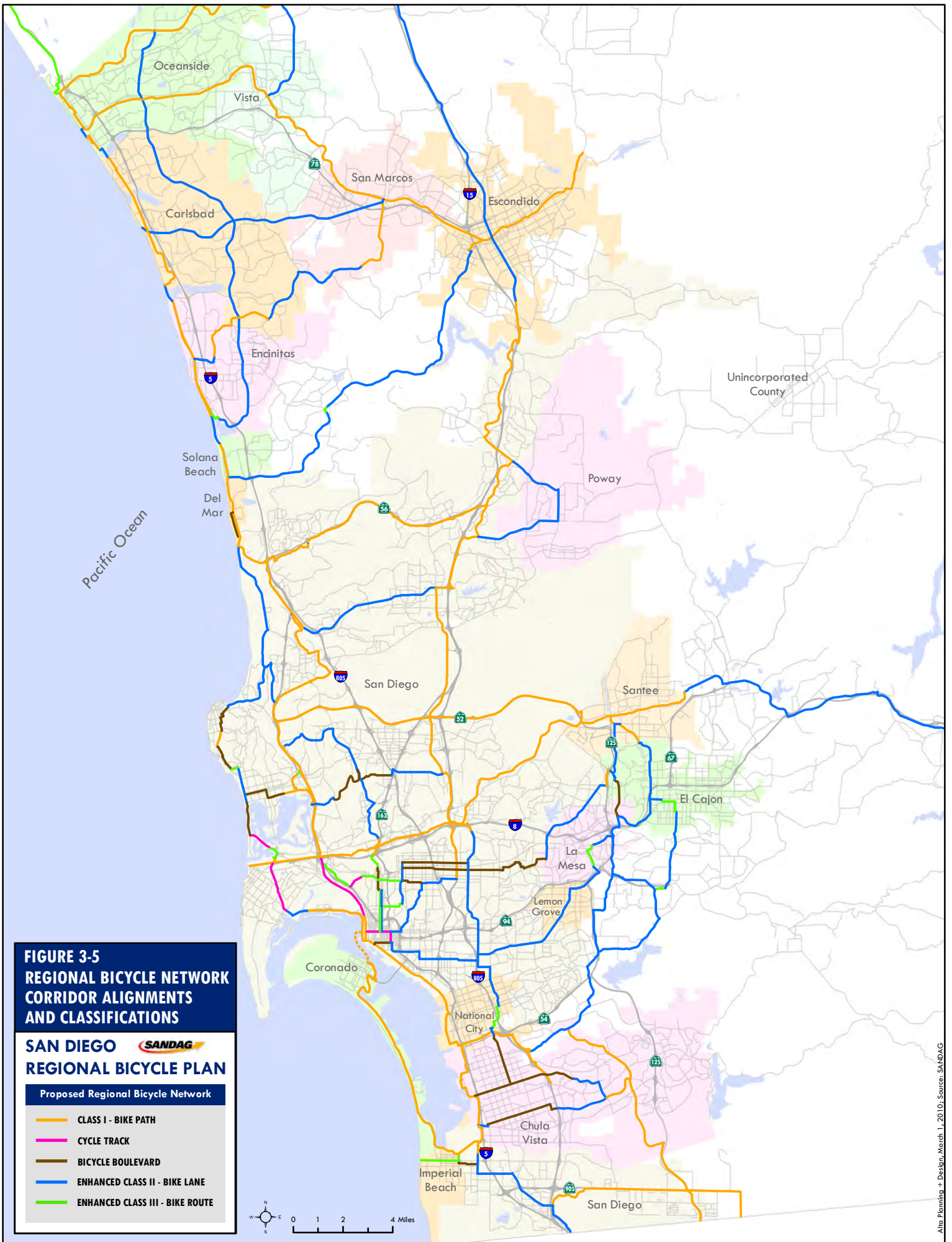

The bicycle network map and summary tables for the constrained revenue funding scenario is provided in Appendix B.

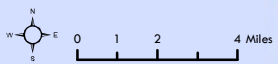

**FIGURE 3-5
REGIONAL BICYCLE NETWORK
CORRIDOR ALIGNMENTS
AND CLASSIFICATIONS**

SAN DIEGO 
REGIONAL BICYCLE PLAN

Proposed Regional Bicycle Network

-  CLASS I - BIKE PATH
-  CYCLE TRACK
-  BICYCLE BOULEVARD
-  ENHANCED CLASS II - BIKE LANE
-  ENHANCED CLASS III - BIKE ROUTE



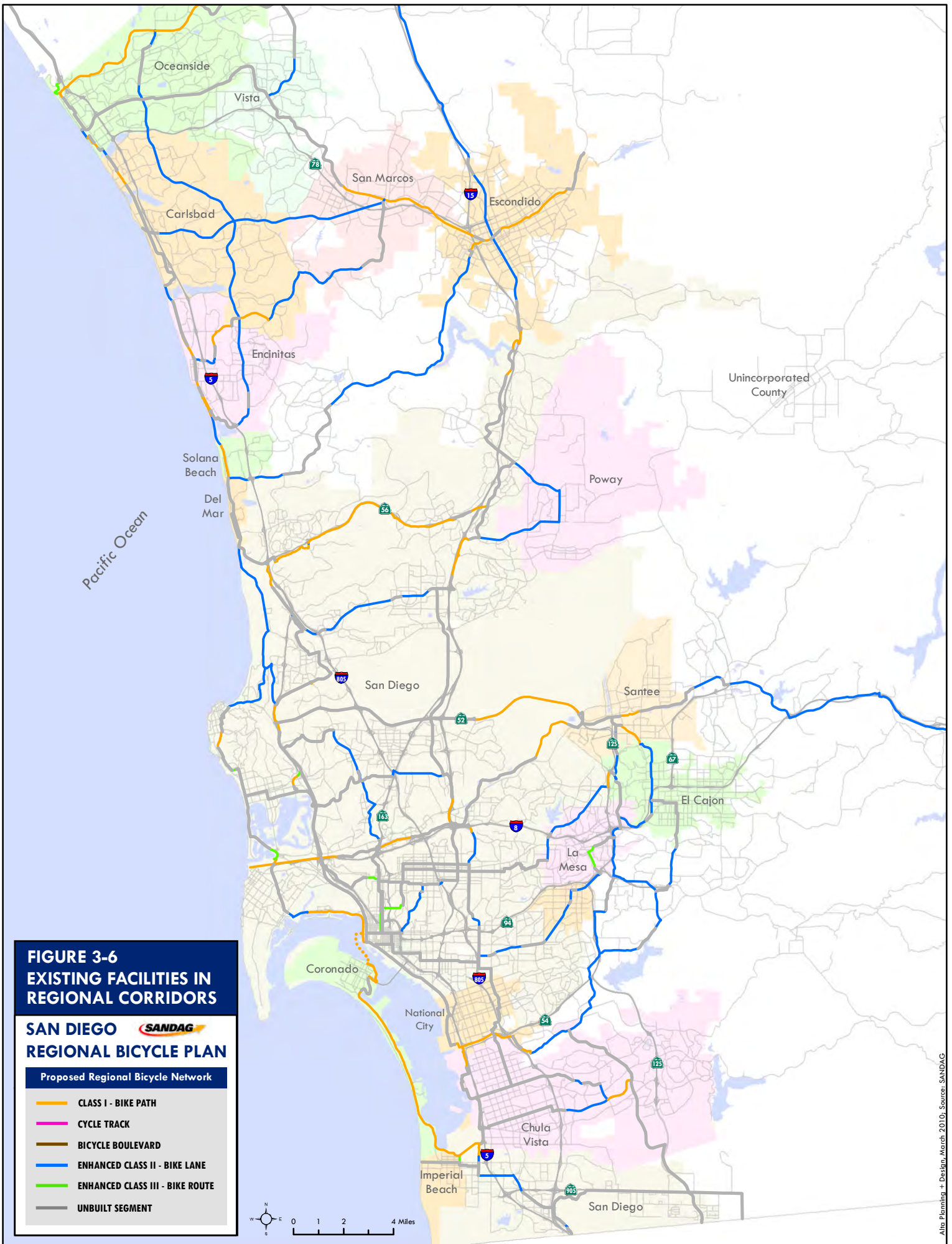
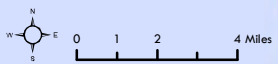

**FIGURE 3-6
EXISTING FACILITIES IN
REGIONAL CORRIDORS**

SAN DIEGO 
REGIONAL BICYCLE PLAN

Proposed Regional Bicycle Network

- CLASS I - BIKE PATH
- CYCLE TRACK
- BICYCLE BOULEVARD
- ENHANCED CLASS II - BIKE LANE
- ENHANCED CLASS III - BIKE ROUTE
- UNBUILT SEGMENT



3.6 Priority Projects

As part of the implementation of the Plan a project prioritization process using criteria adopted by the SANDAG Transportation Committee will be developed and applied to the regional network to phase implementation.

3.6.1 Project Prioritization Process

The prioritization framework will assess estimated bicycling demands and bicycle facility deficiencies across the region. The bicycle travel demand assessment will employ a gravity model approach where the level of demand on any given segment of the proposed network is assumed to be positively correlated with land use intensities of locations being connected, and inversely correlated with the distances between these locations. The Smart Growth Opportunity Areas (SGOAs), as shown on the SANDAG Board adopted Smart Growth Concept Map (Appendix C) will be used to define a set of origins and destinations across the region, with linkages via the proposed regional bicycle network assessed for relative demands. Based upon the gravity model concept, therefore, the higher the land use intensity of a SGOA served by the regional bicycle network, the greater the estimated demand along that particular segment. Likewise, the shorter the distances between any two SGOAs along the regional bicycle network, the higher the estimated demand on that particular segment.

The RCP identifies seven categories of smart growth place types, including the Metropolitan Center, Urban Centers, Town Centers, Community Centers, Rural Villages, Mixed-Use Transit Corridors and Special Use Centers. Each smart growth place type is associated with housing and employment density targets, as well as transit service thresholds. The Smart Growth Concept map was developed in collaboration with the 19 jurisdictions in the San Diego region and includes nearly 200 existing and planned/potential SGOAs. Using SGOAs in the regional bicycle network prioritization process allows the region to emphasize important synergies between its land use, transit, and bicycle planning efforts.

Table 3.5 displays the RCP seven smart growth place types and the respective residential, employment, and transit targets.

Table 3.5
Land Use and Transit Targets for RCP Smart Growth Place Types

Smart Growth Place Type	Minimum Residential Target	Minimum Employment Target	Minimum Transit Service Characteristics
Metropolitan Center	75 du/ac	80 emp/ac	Regional Services
Urban Center	40 du/ac	50 emp/ac	Light Rail/Rapid Bus
Town Center	20 du/ac	30 emp/ac	Light Rail/Rapid Bus
Community Center	20 du/ac	N/A	High Frequency Local Bus within Transit Priority Areas based on the Urban Service Boundary in the 2007-2011 Coordinated Plan
Rural Village	10.9 du/ac	N/A	N/A
Special Use Center	Optional	45 emp/ac	Light Rail/Rapid Bus
Mixed-Use Transit Corridor	25 du/ac	N/A	High Frequency Local Bus

Source: Smart Growth Concept Site Descriptions June 6, 2008 (SANDAG)

Notes:

du/ac = dwelling units per acre

emp/ac = employees per acre

In addition to the demand-based criteria, the prioritization process will also incorporate bicycle network deficiencies and levels of prior facility funding. Specifically, the deficiency assessment will consider bicycle facility gaps, incidence of bicycle crashes, and public comment related to problem areas. Factors such as the presence of a facility gap, high crash locations, more public comment, and prior funding will be given higher priority.

3.7 Regional Bicycle Parking

Secure and convenient bicycle parking is essential to facilitating bicycle transportation, including multimodal trip-chaining where the bicycle is used for a portion of the total trip. The SANDAG iCommute bike locker program continues to advance bicycle-transit integration in the region by managing 872 spaces in bike lockers at 60 transit centers (Trolley, COASTER, SPRINTER, and BRT Stations), and Park and Ride lots throughout San Diego County. iCommute mechanical and electronic lockers can be accessed for a \$25 dollar key deposit fee and are available to users on a first-come, first-served basis. Table 3.6 displays the quantity of iCommute bike lockers and locker spaces by location.

Table 3.6
SANDAG iCommute Bike Lockers in the San Diego Region

Site Name	Total Lockers	Total Spaces
12th and Imperial Trolley Station	2	4
24th Street Trolley Station	2	4
70th Street Trolley Station	6	12
8th Street Trolley Station	4	8
Alvarado Medical Center Trolley	6	12
Amaya Trolley Station	7	14
Bayfront Trolley Station (E Street)	9	18
Beyer Blvd Trolley Station	2	4
Buena Creek (SPRINTER)	9	18
Cal State San Marcos (SPRINTER)	10	20
Carlsbad Village	2	4
Carmel Mtn. Park & Ride #4	4	8
Coast Highway (SPRINTER)	4	8
College Blvd (SPRINTER)	10	20
Crouch St (SPRINTER)	8	16
El Cajon Transit Terminal	8	16
El Camino Real (SPRINTER)	5	10
Encanto Trolley Station	2	4
Encinitas Coaster Station	16	28
Escondido Ave (SPRINTER)	11	22
Escondido Transit Ctr	19	38
Euclid Ave Trolley Station	1	2
Fashion Valley Transit Center	16	16
Fenton Pkwy	2	4
Gillespie Field Trolley (Weld)	6	12
Grantville Trolley Station	6	12
Grossmont Trolley Station	4	8
H St. Trolley Station	11	22
Harborside Trolley Station	1	2
Hazard Center Trolley Station	6	12
Iris Ave Trolley Station	14	28
La Mesa Trolley Station	3	6
Lemon Grove Trolley (Broadway)	4	8
Massachusetts Trolley Station	3	6
Melrose Station (SPRINTER)	7	14
Mission SD Trolley Station	6	12

(Continued on next page)

Table 3.6 (continued)
SANDAG iCommute Bike Lockers in the San Diego Region

Site Name	Total Lockers	Total Spaces
Mission Valley Ctr Trolley	4	8
Morena/Linda Vista Trolley	6	12
Nordahl Road Station (SPRINTER)	8	16
Oceanside Transit Center	10	20
Old Town Transit Center	24	48
Pacific Fleet Trolley Station	2	4
Palm Ave Trolley Station	7	14
Palomar College Station (SPRINTER)	16	32
Palomar Trolley Station	6	12
Poinsettia Coaster Station	6	12
Qualcomm Stadium Trolley	6	12
Rancho Bernardo BRT	8	16
Rancho Carmel Park & Ride #31	2	4
Rancho Del Oro (SPRINTER)	8	16
Sabre Springs BRT	8	16
Sabre Springs Park & Ride #16	2	4
San Marcos Civic Center (SPRINTER)	18	36
Santa Fe Depot	2	4
Santee Trolley Station	20	40
Solana Beach Coaster Station	6	12
Sorrento Valley Coaster	22	44
Spring Street Trolley Station	3	6
Vista Transit Center (SPRINTER)	14	28
Washington Trolley Station	2	4
TOTAL	446	872

Source: SANDAG, 2008

iCommute also reaches out to the community regarding bicycle locker availability via the San Diego Region Bike Map, the iCommute website, and biking advocacy organizations. This form of encouragement is one facet of iCommute's overall efforts to reduce drive-alone vehicular trips through the promotion of alternative commutes.

Providing long-term bike parking at transit centers increases bike-transit trip potential; however, short- and long-term parking facilities are needed elsewhere throughout the region to encourage local bicycle trips by both transit riders and persons traveling solely by bicycle. Many office buildings, commercial districts, and tourist attractions lack sufficient bicycle parking in terms of design and quantity. This discourages people from cycling

because many bicyclists desire reasonable protection against theft, vandalism, and inclement weather. According to the bicycle user questionnaire distributed for the Regional Bicycle Plan planning process, 43 percent of respondents indicated that they would bicycle more frequently if more bike parking was available. An even greater percentage of public workshop participants expressed strong interest in bike parking. Bicycle parking is most effective when it is located close to trip destinations, visible, and easy to use. If quality bicycle parking facilities are not provided, determined bicyclists lock their bicycles to street signs, parking meters, lampposts, or trees, all of which are undesirable because they are often less secure, may interfere with pedestrian movements, and can create liability issues or damage to street furniture or trees.

In addition to maintaining the iCommute bike locker program, SANDAG has a role in providing policy guidance to local jurisdictions to ensure adequate bicycle parking is available throughout the region. Locally adopted and enforced bike parking ordinances are most critical to ensuring bike parking is provided by private developers, yet few jurisdictions in San Diego County currently have an ordinance that mandates specific bike parking requirements. Bike parking ordinances at a minimum should include parameters for the quantity and type of bike parking facilities that are required by type of development. They should also include provisions for the design options and placement of facilities to ensure they are secure, convenient, visible and maneuverable. Chicago, Illinois; Santa Cruz, California; and Madison, Wisconsin have been successful in implementing ordinances that make bike parking compulsory. **Appendix D** provides a model bike parking ordinance and is intended to assist cities in developing a local bike parking ordinance. **Chapter 7** provides a brief overview of effective bike parking design options.

4 Recommended Programs

The infrastructure projects and system improvements recommended by the Plan are intended to be complemented by programs designed to raise awareness of bicycling; connect current and future cyclists to resources; educate people about safe bicycle operation, bicyclists' rights and responsibilities, and lawful interactions between motorists and cyclists; and encourage residents to bicycle more frequently.

The Plan describes several proposed bicycle programs whose success in the San Diego region would be contingent on cooperation between regional agencies, municipal governments, and non-governmental organizations (NGOs) for funding and implementation. In many cases, these programs can be implemented by NGOs provided they are adequately funded.

The selection of programs proposed in this plan is largely derived from a review of strengths and weakness in the region's existing programs as well as a national-level review of best practices. An overview of existing programmatic conditions can be found in Appendix A.

The proposed programs are intended to provide direction to the San Diego region for developing programs that directly support the goals, objectives, and policies of the Plan. This chapter presents a discussion of each of the following program categories:

- Education Programs
- Public Awareness Programs/Marketing
- Encouragement Programs
- Enforcement Programs
- Monitoring & Evaluation

Each section contains an overview of the program category and synopses of representative programs within each category. The presentation of each proposed program includes identification of the target audience, the primary implementing agency, potential partners, key elements of the program, relative cost, potential funding sources, and exemplary programs. The proposed programs were selected based upon information garnered over the course of this planning process, including public input, direction from the Bicycle-Pedestrian Working Group (BPWG) and SANDAG staff, and from an analysis of the likely effectiveness of each program in the San Diego region.

This chapter is intended to introduce a spectrum of programs that are successful in other locations, but are currently absent or underserved the San Diego region. Their introduction serves as a jumping off point for

further exploration of their application. Local governments can use this chapter as a menu of potential programs, select certain programs for further examination, and include this selected subset of programs in their bicycle master plans with more detailed discussions related to implementation in their respective city.

4.1 Education Programs

Education programs ensure that bicyclists, pedestrians, and motorists understand how to travel safely in the roadway environment and are cognizant of the regulations that govern these modes of transportation. Education programs are available in an array of forums from long-term courses with detailed instruction to single session workshops focusing on a specific topic. Curriculums should be tailored to the target audience with specific content varying by audience group and instruction format. The following education programs are recommended for implementation in the region and described in more detail in the remainder of the section:

- Complete Streets Education
- Driver's Education and Diversion Classes
- Safe Routes to School – Phase I
- Cycling Skills and Safety Courses (Adult & Youth)

Complete Streets Education	
Target	City planners and engineers, police officers, construction crews and professional drivers
Primary agency	Local governments
Partners	SANDAG, research and education institutions
Key elements	Internal or off-site educational programs for professionals
Cost	\$50,000 to \$100,000 annually
Potential funding sources	TDA & <i>TransNet</i> funds; California Bicycle Coalition; Municipal Planning Organizations (MPOs)
Sample programs	UC Berkeley ITS TE-19 Course: http://www.its.berkeley.edu/education/

Achieving Complete Streets requires shifting the paradigm of roadway planning and design away from preference to motorists and toward an approach that accommodates all forms of travelers, including bicyclists, pedestrians, transit riders, children, older people, disabled people, and motorists. In 2008 California passed the Complete Streets Act, joining several states and local governments who have adopted a variety of policies to achieve complete streets. Implementing Complete Streets legislation

requires educating professionals whose work directly or indirectly impacts the roadway environment. The San Diego region would benefit from a comprehensive Complete Streets training program that could be made available to city planners, engineers, and decision-makers. The American Planning Association (APA) has developed a *Best Practices Manual on Complete Streets* (<http://www.planning.org/research/streets/>) which is a product of long-term research and collaboration with organizations such as the National Complete Streets Coalition.

Contractors, subcontractors, and city maintenance and utility crews should also receive instruction to ensure they are aware of bicyclists and pedestrians movements and that they follow standard procedures when working on or adjacent to roadways and walkways.

Driver's Education & Diversion Courses	
Target	Learning drivers; traffic violators
Primary agency	Bicycle organizations, traffic courts (i.e. San Diego Superior Court), city transportation departments and police departments
Partners	Driver education schools, court-approved traffic schools
Key elements	Curriculum, testing materials, and training videos
Cost	\$50,000 to \$100,000 annually
Potential funding sources	TDA & <i>TransNet</i> funds; National Highway Traffic Safety Administration
Sample programs	League of American Bicyclists: http://bikeleague.org/programs/education/courses.php League of Illinois Bicyclists: http://www.bikelib.org/video/ The Mobility Education Foundation (Seattle): http://www.mobilityeducation.org Marin County: http://www.marinbike.org/Campaigns/ShareTheRoad/Index.shtml#StreetSkills Portland: http://www.legacyhealth.org/body.cfm?id=1928

Educating beginning drivers on rules related bicycling and how to safely interact with bicyclists provides an opportunity to instill positive attitudes and behaviors when new drivers are developing driving habits. Multiple organizations have created curriculums, instructional videos, and tests to be integrated into driver's education courses that teach new motorists laws and safe practices related to bicycle travel. Programs are frequently initiated through partnerships between city police or transportation

departments and non-profit bicycle organization who conduct the trainings. The Mobility Education Foundation of Seattle has expanded this concept by incorporating mobility related topics, such as health, environmental issues, economics, and multimodal transportation into their curriculum targeting teen driver education students.

Motorist education can also be effectively applied in the form of diversion programs where traffic offenders can elect education in lieu of citations or fines or in exchange for fee reductions. Classes are geared toward motorists, bicyclists, and pedestrians who are violators of bicycle and pedestrian-related traffic violations. Participants receive safety instruction and exposure to laws that impact pedestrian, bicyclist and motorist interaction. In Marin County (CA) the Superior Court refunds a portion of traffic infraction citation fees upon successful completion of a two-hour bicycle safety class that is taught by Marin County Bicycle Coalition professional instructors.

Throughout San Diego County, the Sheriff's Department offices host periodic bicycle rodeos to teach children riding techniques and bicycle traffic laws. Several city police departments also provide educational information to citizens. Local agencies therefore have some experience with these program types; however there is significant opportunity to build upon existing resources and develop more extensive traffic violation diversion programs presented by both enforcement officers and bicycling organization.

Safe Routes to School – Phase 1	
Target	Parents, schoolchildren, administrators, city planners & engineers
Primary agency	SANDAG, San Diego region school districts
Partners	Parent groups at schools, school neighbors
Key elements	Bicycle and pedestrian audit of infrastructure at elementary schools. Recommended route maps.
Cost	\$50,000 to \$100,000 (for first phase only)
Potential funding sources	State-legislated Program (SR2S) and the federally-legislated Program (SRTS) Safe Routes to School grant funding; local, state or national health grants (e.g. Robert Wood Johnson Active Living by Design grants)
Sample programs	Marin County Safe Routes to School: http://www.saferoutestoschools.org/index.shtml Portland Safer Routes to School Program: http://www.trans.ci.portland.or.us/saferoutes/

Safe Routes to School refers to a variety of multi-disciplinary programs aimed at promoting walking and bicycling to school, and improving traffic safety around school areas. Robust Safe Routes to School programs address all of the “Five E’s” (Engineering, Education, Encouragement, Enforcement, and Evaluation) and typically involve partnerships between municipalities, school districts, community and parent volunteers, and law enforcement agencies. Numerous San Diego communities have utilized Caltrans programs to develop Safe Routes to School projects, including neighborhoods in San Diego’s City Heights, East County neighborhoods, and the city of Chula Vista.

For San Diego County school districts that have not implemented a Safe Routes to School Program, an example of a first phase program uses walkabouts (also known as a **bicycle and pedestrian audits**) to assess walking and biking conditions of streets adjacent to elementary schools.



Students participate in a walkabout to evaluate pedestrian conditions

Parents, students, neighbors, city planners, and traffic engineers are invited to join in the walkabout. Safety concerns, issues, and ideas are recorded.

After the bicycle and pedestrian audits are conducted, **maps for each elementary school** showing recommended routes to reach school, along with high-traffic intersections and routes to avoid, are produced and distributed.

As a final step, an **initial infrastructure improvement plan** is produced for each elementary school, including cost estimates and a prioritized project list. This infrastructure improvement plan serves as a blueprint for future investments, and can be used to apply for further grant funding.

Cycling Skills & Safety Courses (Adult & Youth)	
Target	Adult cyclists, school-age children
Primary agency	Bicycle organizations, school districts, cities' public safety, police and planning departments
Partners	Parent groups at schools, community volunteers
Key elements	On-bike skills and safety training
Cost	\$50,000 to \$100,000
Potential funding sources	State-legislated Program (SR2S) and the federally-legislated Program (SRTS) Safe Routes to School grant funding; local, state or national health grants (e.g. Robert Wood Johnson Active Living by Design grants); TDA & <i>TransNet</i> funds
Sample programs	LAB's curriculums: http://www.bikeleague.org/programs/education/index.php BTA's Bike Safety Education Program: http://www.bta4bikes.org/resources/educational.php

Nearly every person in the United States receives in-depth training before receiving a driver's license. Bicycles are also vehicles used on roadways, but most bicyclists do not receive comprehensive training about the rules of the road related to bicyclist-motorist interactions, how bicycles operate, or how to ride a bicycle safely and effectively on the roadway.



Volunteers assist Swiss children through a bicycle skills course

The San Diego County Bicycle Coalition (SDCBC) currently offers adult and youth League of American Bicyclists (LAB) courses taught by League Certified Instructors. Local agencies can partner with the SDCBC and other non-profit organizations to expand course offerings for adults and children and incorporate them into recreation center programs or work with school districts to incorporate bicycle safety into local school curriculums. Courses aimed at children can be taught during school, as a component of a physical education curriculum, or after school.

Common LAB adult courses are Traffic Skills 101, Traffic Skills 102, and Commuting. These courses address topics such as bicycle safety checks and basic maintenance, riding skills, traffic negotiation, and collision avoidance.

An on-bike education curriculum for kids should include:

- Parts of a bicycle
- How a bike works
- Flat fixing
- Rules of the road
- Right of way
- Road positioning
- On-bike skills lessons (braking, turning, steering)
- On-bike community ride

In addition to the LAB curriculums, there are several model programs, such as the Bicycle Transportation Account (BTA) Bike Safety Education Program, available for local adaptation.

4.2 Public Awareness Campaigns & Marketing

Public awareness campaigns are intended to impact the attitudes and behavior of the general public. Public awareness campaigns are high profile efforts that rely on materials, media outreach, and special events to convey a clear message aimed at promoting bicycling and/or improving safety. Share the Road, Street Smarts, Share the Path, and Bike to Work Day/Month are common public awareness campaigns. The following public awareness campaigns and marketing programs are recommended for implementation in the region and described in more detail in the remainder of the section:

- Bike to Work Month
- Share the Road Campaign / Street Smarts
- Share the Path Campaign

Bike to Work Month	
Target	Current and potential cyclists
Primary agency	SANDAG, San Diego County Bicycle Coalition
Partners	Local businesses, other local bicycle clubs and advocacy groups, community volunteers
Key elements	Publicize National Bike Month in May. Offer classes, rides and events.
Cost	\$50,000 to \$100,000+ (depending on scope)
Potential funding sources	Local businesses and bike shops (in-kind or cash support); hospitals and insurance companies; local government agencies
Sample program	Puget Sound Region Bike to Work Month Activities: http://www.cbcef.org/btw/

SANDAG iCommute coordinates Bike to Work Day in May with the assistance of local bicycle organizations and businesses (<http://www.icommutesd.com/Promotions/BikeToWorkDay.aspx>). The popularity of this event has grown significantly in recent years. Supporting activities throughout the month of May, in recognition of National Bike Month, could expand the campaign's impact.

Options for expanding Bike to Work activities during the month of May include offering commute classes, weekly rides, presentations on bicycling for employees, raffles, and commuter incentives. The League of American Bicyclists organization's website provides marketing, educational, and organizational materials to help cities promote and support bike to work week (<http://www.bikeleague.org/programs/bikemonth/>).

Share the Road Campaign/Street Smarts	
Target	All roadway users
Primary agency	Local governments' public safety and police departments, bicycle organizations
Partners	Local bike clubs and organizations
Key elements	Multimedia and printed promotional materials; events
Cost	\$50,000 to \$100,000+
Potential funding sources	State or national health grants (e.g. Robert Wood Johnson Active Living by Design grants); TDA & <i>TransNet</i> funds
Sample programs	Share the Road: http://isharetheroad.com/ City of San Jose Street Smarts: http://www.getstreetsmarts.org/pr_121702.htm

A Share the Road campaign is intended to educate motorists, bicyclists, and pedestrians about their legal rights and responsibilities on the road, and the need to increase safety through courteous and cooperative behavior. The campaign targets all residents and visitors to a community. Developing a Share the Road campaign would require collaboration between local Public Safety Departments (or Police Divisions), San Diego bicycling advocacy groups, and other partners. Establishing Share the Road campaigns generally include:

- Developing **Share the Road** flyers, one targeting bicyclists and one targeting motorists, which outline safe and courteous behavior, collision reporting procedures, and local bicycling resources and hotlines.
- In conjunction with the Police Department, holding **periodic traffic checkpoints** during months with high bicycling rates, where motorists, bicyclists, and pedestrians are stopped, given a Share the Road flyer and have the opportunity to provide feedback to officers regarding the campaign ideas. Checkpoints are typically held along local bikeways and roadways commonly used by bicyclists.
- Producing **public service announcements** on radio and TV to promote the Share the Road campaign, including publicity about the Share the Road checkpoints. Promoting the campaign on involved agencies' websites.
- Creating public PowerPoint **presentations** with the Share the Road message for presentation to the public.
- Developing **adult bicycle safety classes** and holding them at regular intervals.

Similar to a comprehensive Share the Road campaign, Street Smarts, a traffic calming program developed by the City of San Jose, combines an advertising campaign with techniques, such as community events, school presentations, and neighborhood initiatives. Street Smarts aims to provoke fundamental change in the attitudes and behaviors of motorists, pedestrians, and bicyclists.

Share the Path Campaign	
Target	All path users (especially cyclists)
Primary agency	Local governments' planning, police or parks and recreation departments
Partners	Local bicycling clubs and organizations
Key elements	Bell giveaway; maps and information; media outreach.
Cost	\$50,000 to \$100,000
Potential funding sources	Local bike shops (in-kind donations); volunteer time contributions by local cycling groups; in-kind or time contributions; TDA & <i>TransNet</i> funds
Sample programs	Portland Office of Transportation Share the Path brochure: http://www.portlandonline.com/shared/cfm/image.cfm?id=161457

Many cities around the country are implementing “share the path” programs in response to concerns about conflicts between pedestrians and cyclists on shared-use paths. San Diego County is home to numerous popular paths. A Share the Path program will encourage responsible path usage and create community goodwill around bicycling.

Effective Share the Path campaigns generally require the following actions:

- Developing a simple, clear **Share the Path brochure** for distribution through local bike shops and wherever bike maps are distributed.
- Hosting a **bicycle bell giveaway** event on a popular shared-use path. A table is set up with maps and brochures, and knowledgeable staff are present to answer questions.
- Volunteers and agency staff can partner to hand out bells to cyclists. Signs, pavement chalk, and banners are used to explain the event and give cyclists warning so they can stop and receive a bell. Volunteers mount the bells on handlebars (BBB EasyFit bells are recommended because installation requires no tools: <http://www.bbbparts.com/products/accessories/others/bbb12.htm>)
- Volunteers can also walk along the path and give a thank you and a small gift to bicyclists who use their bells when passing.
- Involved agencies conduct **media outreach** before the event. Bell giveaways provide positive stories about bicycling and good visual opportunities for marketing.

4.3 Encouragement Programs

Encouragement programs are generally characterized by their focus on encouraging people to bicycle more frequently, particularly for transportation. Encouragement programs increase the propensity for bicycle trips by providing incentives, recognition, or services that make bicycling a more convenient transportation mode. The following encouragement programs are recommended for implementation in the region and described in more detail in the remainder of the section:

- Bike Sharing Program
- Pilot Smart Trips Program
- Employer Incentive Programs
- Bicycle Friendly Community Designation
- San Diego Region Bike Map
- Identification and Way-finding Signage
- University-base Bike Orientation

Bike Sharing Program	
Target	Bicyclists and potential bicyclists
Primary agency	SANDAG
Partners	Local governments; MTS
Key elements	Rental bikes available at key locations. Comprehensive outreach.
Cost	\$100,000+
Potential funding sources	CMAQ (Congestion Mitigation/Air Quality) funds; SAFETEA-LU; TE, ; public transportation funds; TDA & <i>TransNet</i> funds
Sample programs	Paris' Velib: http://www.en.velib.paris.fr/ Germany's Call a Bike: http://www.callabike-interaktiv.de/kundenbuchung/process.php?proc=english&f=500&key=d77b3782346423c9f6ea41d27f412b00...00000 City of Houston: http://www.publicworks.houstontx.gov/bikeways/bikecampaign.htm

Bike sharing is an innovative approach to urban mobility, combining the convenience and flexibility of a private vehicle with the accessibility and reliability of public mass transit. Public bicycles are available on demand, providing fast and easy access for any trip around a community without the hassles presented by parking a private car or waiting on a transit timetable. When used in combination with other transportation systems, a shared bike program can reduce the travel time between transit stop and office and easily overcome the distance between residences and shopping centers. The

flexibility and freedom presented by a public bicycle program are well suited for modern urban commutes. Bike sharing programs generally facilitate biking for shorter trip distances. Within the regional setting, bike sharing nodes ease congestion in dense urban areas and encourage transit use by inter-jurisdictional commuters by providing a convenient transportation option to make local trips throughout the course of the workday.

Public bicycle programs have gained momentum all over Europe with new networks of rental systems rolling out in a variety of cities. Ninety-plus cities in Europe, Australia, and Asia already take advantage of some form of shared bike infrastructure. Italy, France, Germany, and Spain have all enjoyed the success and popularity of a public bicycle rental system. North America has active bike sharing programs in Washington D.C., Chicago, University of California at Irvine, and Montreal with many other cities planning to implement bicycle systems in the coming years. Sophisticated tracking and transaction technology has contributed to the public appeal of these programs by allowing users to see the availability of bicycles and parking stations live through internet and mobile devices, a level of accessibility on par with, and sometimes surpassing, transit and traditional vehicle parking systems. In most cases this technology and infrastructure can be introduced into any city.

Municipal bike fleet programs have proven successful in several U.S. cities including Houston, San Francisco, and Portland. These programs provide bicycles to city employees to use for free for travel between city buildings and meetings or errands.

Pilot Smart Trips Program	
Target	San Diego County residents who are interested in biking, walking and transit
Primary agency	Local governments
Partners	SANDAG, transit agencies, community volunteers
Key elements	Outreach to a target geographic area promoting biking, walking and transit usage.
Cost	\$100,000+
Potential funding sources	CMAQ (Congestion Mitigation/Air Quality) funds; federal flexible transportation; public transportation funds; hospitals and insurance companies; TDA & <i>TransNet</i> funds
Sample programs	Portland Smart Trips program: http://www.portlandonline.com/transportation/index.cfm?c=ediab

Smart Trips programs (also known as social marketing programs) are encouragement programs based on the concept of saturating a geographic area with resources to help residents reduce drive-alone trips and increase biking, walking, transit, and carpool trips. Smart Trips programs have demonstrated a lasting reduction in drive-alone trips. Target areas in Portland, Oregon for example have experienced a 10% reduction in vehicle traffic.¹⁵

Programs offer residents maps, brochures and other printed materials, classes, guided rides and walks, and other tools and programs that make bicycling, walking, and transit usage a more inviting travel option compared to drive-alone trips.

Measured against infrastructure improvements, these programs are scalable, flexible, inexpensive, and site-independent. Once the program has been established for a specific geographic target area, it can be administered with low start-up costs in other target areas.

This model, however, is unlikely to be successful in areas that have failed to make initial infrastructure investments sufficient to provide a functional bicycling, walking, and transit network. It is most effective as an approach that leverages investments in infrastructure, not one that replaces those investments.

Maps and materials are delivered to interested residents by bike in this Smart Trips program



One of the strengths of the individualized marketing model is that it reaches every resident with an appealing invitation to participate, but then focuses the bulk of resources on those who identify themselves as interested. The

¹⁵ Alta Planning + Design, 2009

many classes, rides, and activities continue to be publicized and open to all, so residents have multiple opportunities to opt into the program. This focus allows for both broad reach and strategic investment.

Implementing a pilot Smart Trips program in a limited geographic area within San Diego County may include any of the following:

- Maps and brochures
- Classes, clinics, workshops
- Guided rides and walks
- Fun social events
- Giveaways (coupons, cyclocomputers, etc.)
- Targeted outreach (e.g. Women on Bikes, Senior Strolls)
- Route planning help (bike, walking, or transit)

Employer Incentive Programs	
Target	Employers in the region
Primary agency	SANDAG, Local governments
Partners	Employers in the region
Key elements	Outreach to employers. Informational materials and possibly monetary awards.
Cost	\$0 to \$50,000
Potential funding sources	CMAQ (Congestion Mitigation/Air Quality) funds; federal flexible transportation; public transportation funds
Sample programs	City of Boston Green Awards: http://www.cityofboston.gov/environmentalandenergy/greenawards/ Bike Commute Challenge (Oregon): http://www.bikecommutechallenge.com/

Employer incentive programs to encourage employees to bicycle to work include strategies such as providing bicycle lockers and shower facilities, offering more flexible arrival and departure times, and financial incentives such as cash bonuses or in-kind gifts to employees who participate. Cities may offer incentives to employers to institute these improvements through lowered parking requirements, reduced traffic mitigation fees, or other means. Cities may also consider an award or certificate program that publicly recognizes businesses demonstrating commitment to non-motorized transportation options by implementing incentive programs.

SANDAG's iCommute program includes the Diamond Awards, an encouragement program that honors San Diego organizations and

individuals promoting alternative travel options such as vanpooling, carpooling, use of public transit, walking, and biking (<http://www.icommutesd.com/Promotions/DiamondAwards.aspx>).

Companies and organizations are eligible to receive one of the following award categories:

- Program Excellence
- Innovation
- Marketing
- Ongoing Commitment
- Best New Program

Programs that promote biking and bike-transit integration may be eligible for an award under each category. However, iCommute may consider revising these categories to include a bike-friendly category or non-motorized transport category in order to elevate awareness of these program types.

Bicycle Friendly Community Designation	
Target	General public
Primary agency	Local governments
Partners	Bicycle advocacy organizations
Key elements	Bicycle Friendly audit and application.
Cost	\$0 to \$50,000 (to apply)
Potential funding sources	Funding may not be required.
Sample programs	Bicycle Friendly Community Information: http://www.bikeleague.org/programs/bicyclefriendlyamerica/communities/

The League of American Bicyclists sponsors an awards program that recognizes cities and counties that actively support bicycling. According to the League, a Bicycle Friendly Community is one that “provides safe accommodation for cycling and encourages its residents to bike for transportation and recreation.” The league recognizes four tiers of bicycle friendly communities: bronze, silver, gold, and platinum. In 2008 the City of Oceanside was the recipient of a Bronze Level Bicycle Friendly Community designation and is the first jurisdiction to receive the distinction in the San Diego region. Other jurisdictions may choose to develop action plans that fulfill the League of American Cyclist’s requirements to become a Bicycle Friendly Community. Bicycle Friendly Community designation promotes bicycling and demonstrates communities’ commitment and willingness to be held accountable.

The application process for being considered as a Bicycle Friendly Community involves an audit of the engineering, education, encouragement, enforcement, evaluation, and planning efforts for bicycling. The League reviews the application and solicits feedback from bicyclists in the community to determine if Bicycle Friendly Status should be awarded. The League provides technical assistance and other information for cities working toward Bicycle Friendly Community status at: www.bicyclefriendlycommunity.org.



Logo that can be displayed on street signs and in public areas

San Diego Region Bike Map	
Target	General public, especially cyclists
Primary agency	SANDAG, local governments
Partners	None
Key Elements	Expand the San Diego Region Bike Map.
Cost	\$0 to \$50,000
Potential funding sources	Additional funding may not be necessary

SANDAG publishes and regularly updates the San Diego Region Bike Map, a free guide that encourages bicycle usage by providing information on bicycle facilities and resources to bicyclists and potential bicyclists. The map displays bikeways and points of interest, including transit centers, bike shop locations, and bike locker stations. It is complimented with iCommute information, rules and safety tips, and bike-transit options in the region.

The San Diego Region Bike Map is an excellent resource that SANDAG should continue to produce. SANDAG should consider expanding distribution to meet the high demand for maps reported by local bicyclists. SANDAG may also consider creating a supplement to the map that provides greater detail on safety, rules of the road, and bike-transit opportunities.

Identification & Way-finding Signage

Target	General public, especially cyclists
Primary agency	SANDAG
Partners	Local Governments
Key Elements	Signage
Cost	To be determined with implementation
Potential funding sources	Low cost; additional funding may not be necessary

System identification raises awareness of the bicycle network and encourages more bicycle trips by making it easier for people to navigate to destinations. System identification generally consists of identifying a series of bicycle routes, designing a unique logo and facility signage, developing a network map, and publicity. Ideally, the system also includes informational kiosks, directional signage pointing out local and regional destinations, and mileage indicators. The Plan recommends that all facilities within the regional bicycle network be complimented with identification and wayfinding signage. This will require coordination with city governments. As system identification plans are usually implemented and maintained by cities, local governments may choose to build upon the regional system to develop city-based wayfinding and identification systems. Recommendations on wayfinding signage design protocol are provided in Chapter 7.

University-Based Bike Orientation

Target	University and college students, especially incoming freshmen
Primary agency	Local governments & universities/colleges
Partners	Student bicycle clubs
Key elements	Bicycle safety & promotion orientation for incoming freshmen and returning students. Classes & clinics, materials, social events, and rides.
Cost	\$50,000 to \$100,000
Potential funding sources	On-campus parking fees, TDM funding sources
Sample programs	Stanford University Bike Program: http://transportation.stanford.edu/alt_transportation/BikingAtStanford.shtml

University students are ideal candidates for bicycling outreach programs; many students live near campus and may not own a car or choose not to

drive. The San Diego region is home to several major universities and colleges, such as San Diego State University (SDSU), University of California–San Diego (UCSD), Cal State University San Marcos (CSUSM), and University of San Diego (USD), however many university campuses and college areas are unaccommodating to bicycle travel. UCSD offers successful biking encouragement programs, including the UCSD Pedal Club and the Triton Bikes Program, a free on-campus bike sharing program. There is also an on-campus UCSD Bike Shop. A bike orientation program is one option for universities to add to or initiate multimodal program strategies. Bike orientation programs encourage bicycling, improve relations between bicyclists and other vehicles, and increase safety for student bicyclists.

Bike orientation programs typically include:

- **Bike maps and information** provided to incoming and returning students at the beginning of the year through school informational packets
- **Flat tire clinics and guided rides**, advertised through flyers, email and bulletin boards, and campus newspapers
- **Information table** hosted at campus events and prominent locations (e.g. campus bookstores, quads) during the first few weeks of school
- A **Bikes at SDSU** (for example) **web page** with links and more information
- At-cost or low-cost **bike lights** sold at tabling events and through campus bookstores

A “bike buddy” program may also be implemented to match current cycling students with interested students. This can be a simple program where bicyclists wear a sticker that says “I bike to SDSU, ask me how,” or a more elaborate program that matches bike buddies with interested students who live in their neighborhood for mentoring. Bike buddy programs increase the cost of university-based programs, but can be an effective tool. SANDAG’s iCommute offers the option of setting up a university network through its Ride Matcher program (<http://www.icommutesd.com/Commuters/RideMatcher.aspx>).

4.4 Enforcement Programs

Enforcement programs target unsafe bicyclist and motorist behaviors and enforce laws that reduce bicycle/motor vehicle collisions and conflicts. Enforcement fosters mutual respect between roadway users and improves safety. These programs generally require coordination between law enforcement, transportation agencies, and bicycling organizations.

Bike Patrol Units & Sting Operations	
Target	General public
Primary agency	Local police departments
Partners	None
Key Elements	On-bike police officers enforcing laws.
Cost	\$0 to \$50,000
Potential funding sources	Additional funding may not be necessary.

Local police departments enforce applicable laws on roadways, depending on available resources and priorities. Vehicle statutes related to bicycle operations are typically enforced on bikeways as part of a department's normal operations. Police departments may consider proactively enforcing bicycle-related violations at high-crash areas. Spot enforcements are highly visible and publicly advertised. They may take the form of crosswalk stings, handing out informational sheets to motorists, bicyclists and pedestrians, or enforcing speed limits and right of way at shared use path-roadway intersections.

As part of a National Highway Traffic Safety Administration grant awarded to Utah's Departments of Health, Transportation, and Public Safety to develop a Share the Road campaign, the State of Utah has developed an enforcement plan that targets motorists who do not share the road with bicyclists. Plainclothes officers on bicycles will stop motorists and cyclists not following the rules of the road and will provide educational material developed as part of the grant, as well as cite the transgressors. An officer on a bicycle will observe the offense and radio to an officer in a chase car who will make the stop. Multiple municipal police forces in the region include bike patrol units, such as the City of San Diego, Escondido and Carlsbad. Bicycle patrol units are encouraged. Bike officers are often viewed as more approachable and undergo special training in bicycle safety and bicycle-related traffic laws and are therefore especially equipped to enforce laws pertaining to bicycling. Bicycle patrol officers also help educate cyclists and motorists through enforcement.

4.5 Monitoring & Evaluation

Monitoring and evaluating local jurisdictions of the region's progress toward becoming bicycle-friendly is critical to ensuring that programs and facilities are effective and to understanding changing needs. Maintaining consistent count programs, reporting on progress, and convening advisory committees are methods for monitoring efforts and for holding agencies accountable to the public. The following monitoring and evaluation

programs are recommended for implementation in the region and described in more detail in the remainder of the section:

- Annual Evaluation Program
- Bicycle Coordinators & Bicycle Advisory Committees Program

Annual Evaluation Program	
Target	None
Primary agency	SANDAG, local governments
Partners	None
Key Elements	Bike and pedestrian counts. A regional non-motorized travel survey. An annual regional progress report.
Cost	\$100,000+
Potential funding sources	None
Sample programs	Copenhagen's City of Cyclists 2006 Report: http://www.vejpark2.kk.dk/publikationer/pdf/464_Cykelregnskab_UK.%202006.pdf City of San Francisco Citywide Bike Count Report: http://www.sfmta.com/cms/rbikes/documents/CitywideBikeCountReport2007.pdf New York City Bicycle Survey: http://www.nyc.gov/html/dcp/pdf/transportation/bike_survey.pdf

The San Diego region is in need of an evaluation program that measures bicycle and pedestrian activity and identifies trends in bicyclists' and pedestrians' behaviors and attitudes. The program should include three major components: 1) collecting bicycle and pedestrian count data; 2) conducting a regional non-motorized travel survey; and 3) generating an annual report which captures changes in bicycling and pedestrian activity and documents the perceptions of residents regarding bicycling and walking in the region. An annual regional progress report should also include progress that has been made toward the implementation of bicycle facilities and programs.

The bicycle and pedestrian count program should be administered annually, geographically representative, and capture all types of bicycle and pedestrian trips including trips for recreation, commuting to work and for other utilitarian purposes. In addition to a regional continuous count program, bicycle and pedestrian counts and assessments should be conducted whenever a local land development project requires a traffic

impact study. A long-term financing source should be identified to guarantee the longevity of the program.

The Seamless Travel Project is a two year Caltrans-funded research effort that investigates correlations between rates of bicycling and walking, and land uses, facility types, and local demographics. The project, in coordination with the National Bicycle & Pedestrian Documentation Project, is one of the larger count and survey efforts in the United States focusing only on bicyclists and pedestrians. Using San Diego County as a case study, this research is the first of its type to develop an extensive database of count and survey data for use in analyzing and identifying factors that influence bicycling and walking. The Seamless Travel Project was initiated in 2007 and concluded in 2009. The final report can be found at http://www.altaplanning.com/App_Content/files/fp_docs/Caltrans-Seamless-Travel-Final-Report.pdf. SANDAG may consider building on the approach of this project to develop an on-going program.

Bicycle Coordinators & Bicycle Advisory Committees (BACs)	
Target	None
Primary agency	Local governments
Partners	SANDAG
Key Elements	Leadership to advise on all bicycle-related issues.
Cost	\$0 to \$100,000+
Potential funding sources	None
Sample programs	- San Francisco's BAC: http://www.sfgov.org/site/bac_index.asp?id=11483 - Oceanside Bicycle Committee: http://www.ci.oceanside.ca.us/Datarelation.aspx?Content=308

All San Diego jurisdictions should pursue filling a local bicycle coordinator position and establishing a Bicycle Advisory Committee (BAC). The majority of cities in the San Diego region do not have bike coordinator positions or BACs. The bike coordinator and BAC will allow cities to take full advantage of bicycle planning efforts and will ensure that bicycle planning and implementation garner the necessary attention of City staff and elected officials. The job duties for a local government bicycle coordinator may include monitoring the design and construction of on-street bikeways and shared use paths, including those constructed in conjunction with private development projects; ensuring bicycle facilities identified in local plans, and as mitigation measures, are designed appropriately and constructed expeditiously; coordinating the

implementation of master plan projects and programs; and serving on the regional BPWG.

BACs generally consist of 10 to 15 members appointed by city councils or boards of supervisors to advise the city or county on issues related to bicycling. BACs make recommendations on facility and program improvements and oversee the implementation of long-range plans, such as bicycle master plans. Committee members are citizens with expertise and commitment to bicycle-related issues and typically represent a geographic area of the city or county.

SANDAG's Bicycle-Pedestrian Working Group (BPWG) is a committee formed to advise SANDAG on the bicycle, pedestrian, and non-motorized facilities component of the RTP and to make recommendations about funding priorities for local bicycle and pedestrian projects. The BPWG is composed of staff members from the 19 local jurisdictions, transit agencies, and bicycle and pedestrian advocacy groups. The BPWG has also provided input on all aspects of the Plan content. Individual advocates and non-profit organizations are currently underrepresented on the BPWG. There may be benefits to expanding participation by non-agency stakeholders so that the group strengthens cooperation between public agencies and citizens and reflects the breadth of perspectives in the region.

5 Air Quality Benefits of Regional Bicycle Network Implementation

This chapter discusses the potential air quality benefits associated with increasing bicycle use. Section two of this Plan’s introduction summarizes several issue areas that are positively impacted by the Plan’s implementation including environmental, public health, economic, community and quality of life, and safety benefits. Collectively these benefits can have a profound influence on the existing and future quality of life in the San Diego region.

One of the primary reasons for developing the Plan is to maximize the number of bicycle commuters in order to help achieve transportation goals such as providing an alternative to driving, and reducing traffic congestion and air pollution. Local and national statistics are used as a basis for estimating the benefits of an improved and expanded regional bicycle network in San Diego. The national statistics are derived from the 2000 U.S. Census and SANDAG forecasts.

5.1 Current System Usage

Understanding how many people bike in the San Diego region is important to developing a baseline against which to measure success and is also vital information for grant applications. This section presents bicycle system usage estimates developed through application of Census data on commuter mode shares to San Diego County.

A primary data source for estimating biking rates is the United States Census and the American Community Survey. Journey to work data was obtained from the 2006 American Community Survey for San Diego County, California, and the United States for comparison. **Table 5.1** displays journey to work data. As shown, approximately 0.6% of San Diego County journey-to-work trips are by bicycle. This is less than the state as a whole.

Table 5.1
Journey to Work Data

Mode	United States	California	San Diego County
Bicycle	0.5%	0.8%	0.6%
Car, Truck or Van – Drive Alone	76.0%	73.0%	80.1%
Car, Truck or Van – Carpool	10.7%	12.4%	11.5%
Public Transit	4.8%	5.0%	3.3%
Walked	2.9%	2.7%	2.9%
Other Means	5.1%	6.1%	1.1%

Source: 2006 American Community Survey

This data is likely an underestimate of the true amount of biking in the county. Census data does not account for the number of people who bicycle for recreation or for utilitarian purposes, students traveling to school, or commuters who travel from outside of the county. Census data also only reflects a person's predominant commute mode and does not count non-motorized trips that are part of a multimodal trip, for example a person who walks or bicycles to a transit station.

5.2 Potential Future Usage and Air Quality Benefits

According to the San Diego County Air Pollution Control District, the monitoring agency of the San Diego Area Basin's air quality, the San Diego region does not currently meet the federal or State eight-hour average ozone standards nor does it meet the stringent State particulate matter (PM10) fine particle standards. In the San Diego region, passenger vehicles are the largest source of air pollution and greenhouse gases (about 41% of the total) that contribute to climate change. By making bicycle travel a safe and functional option for everyday trips to work, school, and shops, the regional bicycle network can help the region improve air quality.

The Climate Action Strategy, SANDAG's guide for addressing climate change, identifies measures that reduce total miles of vehicle travel as one of three potential approaches to reducing greenhouse gas emissions from passenger vehicles. Measures to increase bicycle trips, including implementation of the Plan, are one of several potential policy options to reduce vehicle miles traveled that can help SANDAG reduce greenhouse gas emissions in the 2050 RTP and comply with Senate Bill 375 (Steinberg 2008).

According to Census 2000 trip to work data, the San Diego region's bicycling mode share is 0.6%. This mode share is significantly lower than the actual mode share because it doesn't include people bicycling to school or to transit. By supplementing Census data with estimates of bicycle mode share for students and transit riders, this plan estimates that the actual current number of daily bicycle commuters in San Diego County is closer to 76,037 riders, making 152,075 daily trips and saving an estimated 46,918 VMTs per weekday. The calculations behind this estimate are described below and outlined in Table 5.2.

Table 5.2 quantifies the estimated increase in cyclists and resulting reduction in VMTs in the San Diego region by 2030. It is predicted that progress on implementing the Plan could increase the total number of work and school bicycle commuters from the current estimate of 76,037 (2.7% mode share) to 280,031 (7.0% mode share). Table 5.2 shows the assumptions and calculations applied to generate these estimates. The 7.0%

mode share would result in an estimated decrease of 8,410 pounds/year of particulate matter (PM10 and PM2.5), 1,132,456 pounds/year of hydrocarbons, and 307,261,855 pounds/year of carbon dioxide (CO2). Predicted increases in cycling are based on increases in cycling on newly built bikeways in San Francisco, California; Portland, Oregon; and Seattle, Washington.¹⁶

¹⁶ San Francisco saw 61% corridor increase at 20% network completion, translating to 305% adjusted increase. Portland saw 137% corridor increases at 50% system completion, translating to 274% adjusted increase. Seattle saw 90% corridor increase at 35% system completion, translating to 257% adjusted increase. This translates into an average 279% increase upon system completion. Adjusted increase reflects the projected amount of bicycling that will occur when the system is completed, based on studies of communities with completed or nearly completed bikeway systems. Corridor increases refers to the average increase in bicycling in the corridors in each city, before and after bikeways were installed. System completion refers to the percent completion of the citywide bikeway network in each city.

Table 5.2
Bicycle Commute and Air Quality Projections

Current Commuting Statistics		Source/Calculation
San Diego County Population	2,813,833	2000 US Census
Number of Employed Persons	1,299,503	2000 US Census
Bicycle-to-Work Mode Share	0.6%	2000 US Census
Number of Bicycle Commuters	7,797	Employed persons multiplied by bike-to-work mode share
Work-at-Home Mode Share	4.4%	2000 US Census
Estimated Work-at-Home Bicycle Commuters	28,589	Assumes 50% of population working at home makes at least one bicycle trip per day.
Transit to Work Mode Share	3.3%	2000 US Census
Estimated Transit Bicycle Commuters	10,721	Assumes 25% of transit riders access transit by bicycle.
School Children Grades K-8	190,814	2000 US Census
Estimated School Children Bicycling Mode Share	2.0%	National Safe Routes to School surveys (2003)
Estimated School Bicycle Commuters	3,816	Calculated from above
Number of College Students in Region	251,140	2000 US Census
Estimated College Student Bicycling Mode Share	10.0%	National Bicycling & Walking Study, FHWA, Case Study No. 1, 1995. Review of bicycle commute share in seven university communities (10%)
Estimated College Bicycle Commuters	25,114	Calculated from above
Adjusted Current Commuting Statistics		Source/Calculation
Adjusted Current Estimated Mode Share	2.7%	Mode share including bike-to-work, school, and college bicycle commuters.
Adjusted Current Estimated Total Number of Daily Bicycle Commuters	76,037	Total of bike-to-work, transit, school, and college bicycle commuters. Does not include recreation or utilitarian.
Adjusted Current Estimated Total Daily Bicycle Trips	152,075	Total bicycle commuters x 2 (for round trips)
Reduced Vehicle Trips per Weekday	46,918	Assumes 73% of bicycle trips replace vehicle trips for adults/college students and 53% for school children Based on survey results from 10 California cities conducted by Alta between 1990 and 1999, L.A. Countywide Policy Document survey (1995), and National Bicycling & Walking Study, FHWA, 1995.
Reduced Vehicle Miles per Weekday	361,183	Assumes average round trip travel length of 8 miles for adults/college students and 1 mile for schoolchildren
Reduced Vehicle Miles per Year	94,268,794	Calculated from above
Current Air Quality Benefits		Source/Calculation
Reduced Hydrocarbons (pounds/year)	282,645	1.36 grams per reduced mile (Emissions rates from EPA report 420-F-05-022, 2005.)
Reduced PM10 (pounds/year)	1,081	0.0052 grams per reduced mile (Emissions rates from EPA report 420-F-05-022, 2005.)
Reduced PM2.5 (pounds/year)	1,018	0.0049 grams per reduced mile (Emissions rates from EPA report 420-F-05-022, 2005.)
Reduced NOX (pounds/year)	197,436	.95 grams per reduced mile (Emissions rates from EPA report 420-F-05-022, 2005.)
Reduced CO (pounds/year)	2,577,056	12.4 grams per reduced mile (Emissions rates from EPA report 420-F-05-022, 2005.)
Reduced CO2 (pounds/year)	76,688,206	369 grams per reduced mile (Emissions rates from EPA report 420-F-05-022, 2005.)

(Continued on next page)

Table 5.2, Continued
Bicycle Commute and Air Quality Projections

Estimated Future Bicycle Commuting Statistics		Source/Calculation
2030 San Diego County Population	3,984,753	<i>SANDAG 2030 Population Forecast</i>
Future Employed Population Estimate	1,913,822	<i>SANDAG 2030 Employment Population Forecast</i>
Adjusted Future Estimated Mode Share	7.0%	<i>Estimate of the potential mode share based on other jurisdictions experiences with system development.</i>
Future Total Number of Bicycle Commuters	280,031	<i>Total bike-to-work, school, college, and work-at-home biking trips. Does not include recreation.</i>
Future Total Daily Bicycle Trips	560,062	<i>Future daily bicycle commuters x 2</i>
Future Reduced Vehicle Trips per Weekday	189,035	<i>Assumes 73% of bicycle trips replace vehicle trips for adults/college students and 53% for school children</i>
Future Reduced Vehicle Miles per Weekday	1,447,130	<i>Assumes average round trip travel length of 8 miles for adults/college students and 1 mile for schoolchildren</i>
Future Reduced Vehicle Miles per Year	377,700,902	<i>Calculated from above</i>
Future Air Quality Benefits		Source/Calculation
Reduced Hydrocarbons (pounds/year)	1,132,456	<i>1.36 grams per reduced mile (Emissions rates from EPA report 420-F-05-022, 2005.)</i>
Reduced PM10 (pounds/year)	4,330	<i>0.0052 grams per reduced mile (Emissions rates from EPA report 420-F-05-022, 2005.)</i>
Reduced PM2.5 (pounds/year)	4,080	<i>0.0049 grams per reduced mile (Emissions rates from EPA report 420-F-05-022, 2005.)</i>
Reduced NOX (pounds/year)	791,054	<i>.95 grams per reduced mile (Emissions rates from EPA report 420-F-05-022, 2005.)</i>
Reduced CO (pounds/year)	10,325,331	<i>12.4 grams per reduced mile (Emissions rates from EPA report 420-F-05-022, 2005.)</i>
Reduced CO2 (pounds/year)	307,261,855	<i>369 grams per reduced mile (Emissions rates from EPA report 420-F-05-022, 2005.)</i>

Notes: Sources as noted in the table.

6 Implementation and Financing

This chapter describes the assumptions used to develop the estimated costs of implementing the regional bicycle network and supporting regional programs. It presents alternative strategies for implementing the Plan, identifies the funding sources available to the SANDAG bicycle program, and financing alternatives for implementing the regional network. It concludes with a discussion of recommended strategies for monitoring the effectiveness of the Plan and its implementation, including updating the Plan on a periodic basis.

6.1 Costing Methods and Estimates

The cost to complete the regional corridor network were estimated using unit costs for each facility type that were developed in conjunction with SANDAG staff and a review of unit costs from other jurisdictions.

Table 6.1 displays the unit costs employed for this planning process.

Build out of the regional bicycle network will result in 153.9 miles of new Class I facility, 51.6 miles of new enhanced Class II facility, 27.2 miles of new enhanced Class III, 34.2 miles of bicycle boulevard, and 8.3 miles of cycle track. The estimated cost for build out of the regional bicycle network is \$419 million. Table 6.2 displays these estimated costs by regional corridor and facility type.

Costs for education and encouragement programs, which are discussed in Chapter 4, would result in ongoing annual costs of up to \$1.3 million depending on the number and size of the programs operated each year.

Table 6.1
Unit Costs Used for Estimating Costs of Regional Bicycle Network

Facility Type	Unit	Base Cost	Survey / Design (10%)	Contingency (10%)	Admin (5%)	Traffic Control and Mobilization (7%)	Total Cost per Mile*	Source(s)
Bike Path (Class I)	Mile	\$2,000,000	\$200,000	\$200,000	\$100,000	\$140,000	\$2,640,000	San Diego Association of Governments (2008)
Bike Boulevard 1	Mile	\$84,000	\$8,400	\$8,400	\$4,200	\$5,900	\$110,900	Milpitas (CA) Bikeway Master Plan Update - Public Draft (2008); Lafayette Bikeways Master Plan (2006); Caltrans Approved BTA Projects FY2006/2007, FY2007/2008 and FY2008/2009
Bike Boulevard 2	Mile	\$94,000	\$9,400	\$9,400	\$4,700	\$6,600	\$124,100	Milpitas (CA) Bikeway Master Plan Update - Public Draft (2008); Lafayette Bikeways Master Plan (2006); Caltrans Approved BTA Projects FY2006/2007, FY2007/2008 and FY2008/2009
Cycle Track	Mile	\$341,800	\$34,200	\$34,200	\$17,100	\$23,900	\$451,200	Milpitas (CA) Bikeway Master Plan Update - Public Draft (2008); Mammoth Lakes (CA) Trail System Master Plan - Public Draft (2008); Columbus (OH) Bicentennial Bikeways Plan (2008); La Grande (OR) Pedestrian and Bicycle Improvement Plan (2007)
Bike Lane (Class II)	Mile	\$22,700	\$2,300	\$2,300	\$1,100	\$1,600	\$30,000	Milpitas (CA) Bikeway Master Plan Update - Public Draft (2008); Mammoth Lakes (CA) Trail System Master Plan - Public Draft (2008); Columbus (OH) Bicentennial Bikeways Plan (2008); La Grande (OR) Pedestrian and Bicycle Improvement Plan (2007)
Bike Lane (Class II) w/ Widening	Mile	\$206,800	\$20,700	\$20,700	\$10,300	\$14,500	\$273,000	Milpitas (CA) Bikeway Master Plan Update - Public Draft (2008); Mammoth Lakes (CA) Trail System Master Plan - Public Draft (2008); La Grande (OR) Pedestrian and Bicycle Improvement Plan (2007)
Bike Route (Class III)	Mile	\$11,200	\$1,100	\$1,100	\$600	\$800	\$14,800	Milpitas (CA) Bikeway Master Plan Update - Public Draft (2008); Mammoth Lakes (CA) Trail System Master Plan - Public Draft (2008); Carlsbad (CA) Bikeway Master Plan (2007)

Source: Alta Planning+Design, April 2009

*Note: Base cost does not include right-of-way acquisition

Table 6.2
Regional Bicycle Network Cost Estimate

ID	Name	Beginning	End	Total Miles	Miles of Unbuilt Facility							Cost of Unbuilt Portion
					Unbuilt Miles	Class I	Class II ¹⁷	Class II ¹⁸	Class III	Bike Blvd	Cycle Track	
1	Bayshore Bikeway	Central Coast Corridor	Central Coast Corridor	23.8	11.2	11.2	0	0	0	0	0	\$29,568,000
2	Bay to Ranch Bikeway	Bayshore Bikeway	Chula Vista Greenbelt Otay River	7.4	4.8	0	0	0.7	0	4.1	0	\$502,750
3	Border Access Corridor (Preferred Alternative)	Bayshore Bikeway	San Ysidro Border Crossing, San Diego	6.4	3.1	0	0	3.1	0	0	0	\$93,000
4	Camp Pendleton Trail	Northern boundary of County of San Diego	San Luis Rey River Trail, Oceanside	18.9	18.1	0	0	0	18.1	0	0	\$267,880
5	Carlsbad – San Marcos Corridor	Coastal Rail Trail, Carlsbad	Inland Rail Trail, San Marcos	10.3	0.7	0	0.7	0	0	0	0	\$191,100
6	Central Coast Corridor	Coastal Rail Trail, Del Mar	Bayshore Bikeway, San Diego	22.1	8.5	0	0	1.5	0.1	3.8	3.1	\$1,891,700
7	Centre City – La Mesa Corridor	Bayshore Bikeway, San Diego	SR-125 Corridor	13.7	7.5	0	0	6.8	0	0.7	0	\$286,250
8	Chula Vista Greenbelt Otay River (Preferred Alternative)	Bayshore Bikeway, San Diego	SR-125 Corridor, Chula Vista	5.7	3.8	0	0	0.8	0	3.0	0	\$376,500
9	City Heights – Old Town Corridor	Coastal Rail Trail	I-15 Bikeway	6.2	5.5	0	0	1.3	2.6	0.9	0.7	\$499,070
10	Clairemont – Centre City Corridor	Coastal Rail Trail	North Park – Centre City Corridor	13.9	7.7	0.9	0	4.2	1.5	1.1	0	\$2,653,450
11	Coastal Rail Trail	San Luis Rey River Trail, Oceanside	Bayshore Bikeway, San Diego	44.3	34.0	29.5	0	0.2	0	1.2	3.1	\$79,425,720
12	East County Northern Loop	SR-125 Corridor, La Mesa	SR-125 Corridor, County of San Diego	9.2	3.7	0	2.3	0	1.4	0	0	\$648,620

(Continued on next page)

¹⁷ Class II with constraints.

¹⁸ Class II without constraints.

Table 6.2 (continued)
Regional Bicycle Network Cost Estimate

ID	Name	Beginning	End	Total Miles	Miles of Unbuilt Facility							Cost of Unbuilt Portion
					Unbuilt Miles	Class I	Class II ¹⁹	Class II ²⁰	Class III	Bike Blvd	Cycle Track	
13	East County Southern Loop	East County Northern Loop, El Cajon	SR-125 Corridor, County of San Diego	4.3	1.1	0	0	1.1	0	0	0	\$33,000
14	El Camino Real	San Luis Rey River Trail, Oceanside	Coastal Rail Trail, Encinitas	20.0	3.8	0	3.2	0	0.6	0	0	\$882,480
15	Encinitas – San Marcos Corridor	Coastal Rail Trail, Encinitas	Inland Rail Trail, San Marcos	13.3	4.2	4.1	0.1	0	0	0	0	\$10,851,300
16	Escondido Creek Bikeway	I-15 Bikeway, Escondido	Valley Centre Rd, Escondido	5.9	2.3	2.3	0	0	0	0	0	\$6,072,000
17	Gilman Connector	Central Coast Corridor, San Diego	Coastal Rail Trail	2.0	0	0	0	0	0	0	0	0
18	Hillcrest – El Cajon Corridor	Kensington – Balboa Park Corridor	SR-125 Corridor	11.5	6.8	0	0	0.4	0	6.4	0	\$764,000
19	Imperial Beach Connector	Seacoast Drive, Imperial Beach	Border Access	2.6	2.4	0	0	0	1.5	0.9	0	\$127,950
20	Inland Rail Trail	Coastal Rail Trail, Oceanside	I-15 Bikeway, Escondido	20.7	14.8	14.8	0	0	0	0	0	\$39,072,000
21	Kearny Mesa – Beaches Corridor (Preferred Alternative)	Central Coast Corridor, Pacific Beach	I-15 Bikeway, San Diego	10.4	8.4	1.6	1.0	0	0	5.8	0	\$5,178,500
22	Kensington – Balboa Park Corridor	Clairemont – Centre City Corridor	Mission Valley – Chula Vista Corridor	5.3	4.3	0	0	1.7	0	2.6	0	\$356,500
23	North Park – Centre City Corridor	City Heights – Old Town Corridor	Coastal Rail Trail	3.7	1.5	0	0	0.5	0	0	1.0	\$466,200
24	Mid-County Bikeway Corridor	Coastal Rail Trail, Del Mar	Inland Rail Trail	17.3	4.6	0	0	4.4	0.2	0	0	\$134,960

(Continued on next page)

¹⁹ Class II with constraints.

²⁰ Class II without constraints.

Table 6.2 (continued)
Regional Bicycle Network Cost Estimate

ID	Name	Beginning	End	Total Miles	Miles of Unbuilt Facility							Cost of Unbuilt Portion
					Unbuilt Miles	Class I	Class II ²¹	Class II ²²	Class III	Bike Blvd	Cycle Track	
25	Mira Mesa Corridor	Coastal Rail Trail, San Diego	I-15 Bikeway	6.5	1.8	0.7	1.1	0	0	0	0	\$2,148,300
26	Mission Valley - Chula Vista Corridor	San Diego River Bikeway, San Diego	Bay to Ranch Bikeway, Chula Vista	12.5	10.3	0.7	2.1	4.2	1.2	2.1	0	\$2,811,810
27	Park Boulevard Connector	North Park - Centre City Corridor	Centre City - La Mesa Corridor	0.4	0.4	0	0	0	0	0	0.4	\$180,480
28	Poway Loop	I-15 Bikeway, San Diego	I-15 Bikeway, San Diego	6.9	0	0	0	0	0	0	0	0
29	San Diego River Bikeway	Voltaire St, San Diego	SR-125 Corridor, Santee	17.9	10.7	10.7	0	0	0	0	0	\$28,248,000
30	San Luis Rey River Trail	Coastal Rail Trail, Oceanside	I-15 Bikeway, County of San Diego	18.4	10.7	10.7	0	0	0	0	0	\$28,248,000
31	Santee - El Cajon Corridor	El Cajon Northern Loop, El Cajon	I-8 Corridor, Santee	3.9	0.2	0	0	0.2	0	0	0	\$6,000
32	Sweetwater River Bikeway	Bayshore Bikeway, National City	SR-125 Corridor, Chula Vista	5.2	0.6	0.6	0	0	0	0	0	\$1,584,000
33	Vista Way Connector	San Luis Rey River Trail	Inland Rail Trail	4.6	2.5	0	2.5	0	0	0	0	\$682,500
34	I-8 Corridor	SR-125 Corridor	Japatul Valley Rd, County of San Diego	25.0	9.9	6.0	0	3.9	0	0	0	\$15,957,000
35	I-15 Bikeway	Northern boundary of County of San Diego	City Heights - Old Town Corridor	55.1	24.2	23.5	0.7	0	0	0	0	\$62,061,000
36	SR-52 Bikeway	Coastal Rail Trail, San Diego	San Diego River Bikeway, San Diego	13.5	13.5	13.5	0	0	0	0	0	\$35,640,000
37	SR-56 Bikeway	Coastal Rail Trail, San Diego	I-15 Bikeway, San Diego	10.7	1.2	1.2	0	0	0	0	0	\$3,168,000

(Continued on next page)

²¹ Class II with constraints.

²² Class II without constraints.

Table 6.2 (continued)
Regional Bicycle Network Cost Estimate

ID	Name	Beginning	End	Total Miles	Miles of Unbuilt Facility							Cost of Unbuilt Portion
					Unbuilt Miles	Class I	Class II ²³	Class II ²⁴	Class III	Bike Blvd	Cycle Track	
38	SR-125 Corridor	San Diego River Bikeway, Santee	Olay Mesa Border Crossing, San Diego	25.1	15.6	11.1	0	2.9	0	1.6	0	\$29,579,000
39	I-805 Connector	Sweetwater River Bikeway	Telegraph Canyon Road, Chula Vista	1.8	1.8	1.8	0	0	0	0	0	\$4,752,000
40	SR-905 Corridor	Border Access Corridor, San Diego	Future SR-11 Border Crossing, County of San Diego	9.0	9.0	9.0	0	0	0	0	0	\$23,760,000
TOTALS				515.5	275.2	153.9	13.0	38.6	27.2	34.2	8.3	\$419,169,020

Source: Alta Planning+Design, March, 2010

6.2 Funding Sources

Historically, the primary sources of revenue for developing bicycle programs and projects in the region have been the *TransNet* Active Transportation Program, which funds bicycle, pedestrian, and neighborhood safety (traffic calming) projects and programs, and the Transportation Development Act (TDA) Article 3 Non-motorized funds. Eligible support programs include those that help to encourage walking and the use of bicycles, such as secure bicycle parking facilities and bicycle and pedestrian promotion and safety education programs. Regional projects have also benefited from the availability of federal transportation funds, and to a lesser extent, state funds. In fact, the *TransNet* Extension Ordinance states that the *TransNet* Active Transportation funds should be used to match federal, state, local, and private funding to maximize the number of improvements to be implemented. Each of these funding sources, and the level of funding available, is discussed below.

6.2.1 Regional Funding Sources

TransNet Active Transportation Program. The *TransNet* 1/2-cent transportation sales tax program has provided approximately \$31.4 million in sales tax revenues and interest earnings for active transportation projects since it was first began in FY 1988. For the first 20 years, \$1 million was designated for bicycle facilities and programs each year. With the passage of the *TransNet*

²³ Class II with constraints.

²⁴ Class II without constraints.

Extension Ordinance, which began in FY 2009, the funding increased to two percent of the annual revenues, and the purposes for which the funds could be expended were broadened to include pedestrian and neighborhood safety (traffic calming) projects. Over the years, these *TransNet* funds supported regional bikeway development primarily by serving as the local match for federal funds. The overwhelming majority of the funds have gone to local projects through an annual competitive grant process. The *TransNet* program will end in 2048. Projected revenues for the Active Transportation Program between FY 2011 and the end of the program are estimated to be \$232 million in current dollars as shown in **Table 6.3**.

Transportation Development Act (TDA) Article 3. The TDA program is funded by 1/4-cent of the statewide sales tax based on sales taxes collected within San Diego County. Of that amount, two percent is set aside for bicycle and pedestrian programs and projects. Annual revenues currently are about \$1.8 million. SANDAG administers these funds in the San Diego region as part of its Active Transportation Program. The funds are distributed to cities and the County through the same competitive grant process used to award *TransNet* active transportation grants. Revenues for TDA funds are also shown in Table 6.3.

Table 6.3
Active Transportation Program Funds

Fiscal Years	TransNet	TDA	Total
2011	\$3,874,000	\$1,787,000	\$5,661,000
2012	3,918,000	1,840,000	\$5,758,000
2013	4,028,000	1,890,000	\$5,918,000
2014	4,244,000	1,994,000	\$6,238,000
2015	4,418,000	2,076,000	\$6,494,000
2011-2015	\$20,482,000	9,587,000	\$30,069,000
2016-2020	23,719,000	11,143,000	\$34,862,000
2021-2048	187,581,000	88,124,000	275,705,000
Total	\$231,782,000	\$108,854,000	\$340,636,000

6.2.2 Federal Funding Sources

The current federal transportation funding authorization is known as *Safe, Accountable, Flexible, Efficient Transportation Equity Act – A Legacy for Users (SAFETEA-LU)*. It is the third iteration of the transportation vision established by Congress in 1991 with the Intermodal Surface Transportation Efficiency Act (ISTEA) that takes a multimodal approach to transportation

planning. It allows flexibility in the use of funds under the various funding programs, which makes bicycle projects eligible in most funding categories. SAFETEA-LU expired in October 2009, so the federal transportation program has been continuing under a series of extensions enacted by Congress. In light of the uncertainty about the form and funding levels of the next federal authorization, this plan assumes a continuation of the existing federal programs with funding levels consistent with recent authorizations and with funding estimates provided by the California Transportation Commission (CTC).

While bicycle projects are eligible under most federal funding programs, current SANDAG policy dedicates 94 percent of all discretionary funding to the *TransNet* Early Action Projects (EAP). These are the major corridor projects that support highway and transit corridor project development. Regional bikeway projects could be built with the funds dedicated to the EAP if they are identified as mitigation for those projects, but for the most part, the bikeway projects will need to compete for the remaining six percent of federal funds where there already is significant demand from other eligible project types. There are, however, several federal programs that restrict funds to specific categories of projects, and some of these could be used to support development of regional bikeway projects.

Transportation Enhancement Funds. The most common source of federal funds for bicycle projects is the Transportation Enhancements (TE) Program. Based on the assumption that the TE program will be included in the next federal transportation authorization, the state has estimated funding levels for the program through FY 2015 as shown in Table 6.4.

Table 6.4

Federal Transportation Enhancement Program Revenue Estimates*

FY 2011	FY 2012	FY 2013	FY 2014	FY 2015	Total
\$1,356,000	\$3,624,000	\$4,311,000	\$5,326,000	\$5,327,000	\$19,944,000

*Based on revenue estimates provided by the California Transportation Commission

TE funds may be used to fund 12 specified types of projects, including bicycle and pedestrian facilities. Using the discretion over these funds granted to regional agencies by state law, SANDAG has in the past chosen to focus the use of TE funds on projects that support specific regional priorities. Most recently, the funds were used for a pilot program to demonstrate how transportation funding can be used to develop projects that support and provide incentives for smart growth. That discretion could be used to dedicate future TE funds to regional bikeway implementation. While local agencies may want the opportunity to compete for these funds

as they have in the past, focusing TE funds on regional bikeways would reduce the amount of local *TransNet* and TDA funds necessary for the regional network, leaving more of those funds for local projects. In addition, it would consolidate the administrative burden that comes with federal funds on a few larger projects.

Safe Routes to School. SAFTEA-LU established a federal Safe Routes to School program to support projects that encourage more children to walk or ride a bike to school. Metropolitan planning organizations (MPOs) like SANDAG are eligible to receive grants under this program, which is administered in California through Caltrans. The last cycle of projects provided \$46 million for 106 projects. Eligible projects must be within two miles of a school. Projects on the regional network that directly serve schools could potentially benefit from this funding source.

Congestion Mitigation and Air Quality Funds (CMAQ). Projects that help meet national goals for improved air quality and congestion relief, including bicycle projects, are eligible for CMAQ funds. Several regional bikeway projects, including the Coastal Rail Trail, Inland Rail Trail and the Bayshore Bikeway have been developed in part with CMAQ funds. However, because these funds are subject to SANDAG policy to dedicate 94 percent of discretionary funds to the EAP, this cannot be considered a viable source of funding for regional bikeway implementation in the near term.

Land and Water Conservation Fund. This program, administered by the National Parks Service, allocates money to state and local governments to acquire new land for recreational purposes, including bicycle paths and support facilities such as bike racks. Funding allocated to California is administered by the State Department of Parks and Recreation. Eligible applicants include cities, counties and districts authorized to acquire, develop, operate and maintain park and recreation areas. For local agencies, funds are provided through a competitive selection process. There is a 50% local match requirement. The Land and Water Conservation Fund has not been used to date in the San Diego region to develop the regional bikeway network.

Recreational Trails Program. This program provides funds for developing and maintaining recreational trails and trail-related facilities for both non-motorized and motorized recreational trail uses. Examples of trail uses include hiking, bicycling, in-line skating, equestrian use, and other non-motorized as well as motorized uses. While bikeway projects have been developed through this program, the urban location and transportation emphasis of the regional bike network suggests this will not be a major source of revenue for project implementation. There are, however, recreational trails in the region that do serve a transportation function. Even

if this program did not fund the regional network, it is available as a potential source of funds for local bikeway projects that qualify and would compete well under the program. The Recreational Trails Program is administered in California by California State Parks. Approximately \$6 million was available statewide for this program in the last funding cycle.

6.2.3 State Funding Sources

Bicycle Transportation Account (BTA). The BTA is an annual statewide discretionary program that is available through Caltrans for funding bicycle projects. The grants to cities and counties provide \$7.2 million each year with an emphasis on funding projects that benefit bicycling for commuting purposes. The local match must be a minimum of ten percent of the total project cost. BTA funds have been used to develop regional bikeways like the Inland Rail Trail, but should SANDAG be responsible for regional project development, it would only be available through a cooperative agreement with a local agency that agreed to apply for the funds on SANDAG's behalf.

Safe Routes to School. The state of California was a pioneer in establishing a state Safe Routes to School program ten years ago using funds from the Hazard Elimination Safety program. Like the federal program, its purpose is to encourage walking and bicycling to school by eliminating barriers to bicycle and pedestrian travel, and by implementing education and encouragement campaigns. The most recent funding cycle provided \$24 million statewide. Like the BTA, only cities and counties are eligible under the state program, and a ten percent local match is required. Projects on the regional network that directly serve schools could potentially benefit from this funding source.

Other Potential Funding Sources. There are a variety of other sources of funds that have or could be used to support bikeway development in the region. These sources include:

- Federal demonstration grants been awarded through the San Diego congressional delegation
- Federal economic stimulus funds
- State bond funds such as Proposition 84 park bonds
- Local gas tax or *TransNet* Local Systems funds
- Development impact fees or other developer assessments

Finally, federal, state and local complete streets policies establish the responsibility to provide for all modes of travel when developing transportation projects. Following complete streets guidelines, wherever a regional network project coincides with other highway, local streets and

roads or transit projects, the projects should be developed concurrently to take advantage of the costs and time savings that could be realized through economies of scale and coordinated implementation.

6.3 Implementation

The key implementation steps that will follow adoption of the Plan and will include employing the Plan's project prioritization criteria to develop a list of priority regional corridor projects, developing an implementation strategy for how the regional network will be completed and programmatic components of the Plan implemented, and developing a financial plan for implementing the projects and programs. These follow-up steps will be completed through the summer of 2010 so the Plan recommendations can be incorporated into the 2050 RTP.

The Plan represents a significant step forward in bicycle planning for the region. It includes more comprehensive and detailed recommendations for the regional bicycle network and supporting programs that were previously developed through the regional transportation plan process, and it establishes ambitious goals to make bicycling a significant contributor to the region's transportation system. With this new and ambitious plan comes the opportunity to re-evaluate the region's approach to project development and financing.

6.3.1 Project Development

SANDAG's current role in developing the regional bicycle network has been to identify and administer funding sources, encourage local agencies to take on regional projects, and provide guidance and oversight as projects are developed. This approach is a reflection of SANDAG's role as the administrator of transportation funding in the region, but it has its limitations. Implementation of corridor projects that have a high priority at the regional level have had to compete against local priorities for resources. At times this has led to long project development timelines. Different priorities for regional projects between jurisdictions have resulted in the development of discontinuous segments for multi-jurisdictional bicycle facilities. In addition, educational and promotional programs that could have been deployed regionwide have been restricted to the single jurisdiction that is awarded funding for the project, reducing the program's impact. Two alternative approaches to implementation are suggested for further consideration: 1) provide increased incentives in the Active Transportation funding program to encourage local agencies to implement regional projects; and 2) establish agreements between SANDAG and local agencies that enables SANDAG to be the lead agency for project implementation.

SANDAG awards funds to local jurisdictions under its Active Transportation program through a competitive grant process. Projects are selected based on established criteria that are designed to select projects with high potential demand that increase safety, and that are cost effective and ready for development. These criteria could be revised to place a premium on funding regional projects. With this approach, SANDAG also may want to increase its oversight role to help ensure timely project development and a consistent approach to design and operation for regional bikeways. This approach would be consistent with the implementation framework established in the RCP adopted in 2004 that focuses on collaborative planning and incentives to achieve regional goals.

The current approach to developing regional bikeways was developed before the consolidation of regional transportation implementation responsibilities at SANDAG. Taking advantage of this new capacity, a second approach would be to implement the regional bicycle program in a manner more akin to how regional transit projects are developed with SANDAG taking lead in planning, design and construction, and the local agency assuming responsibility for on-going operation and maintenance. Investing SANDAG with the responsibility to implement regional projects would require cooperative agreements between SANDAG and local agencies that addressed how construction, operation, and maintenance would occur. It also would require changes in the way regional funds are allocated since current active transportation funding decisions are made through a process designed to dispense funds to local agencies.

Maintenance. Maintenance and funding for maintenance is a significant issue for all public rights of way whether it is for general roadways or separate bicycle and pedestrian facilities. Historically, the funding that has been administered by SANDAG for bicycle and pedestrian projects has not been available for maintenance, and the Plan does not include specific provisions for maintenance of the facilities proposed in the Plan. This issue will be addressed as part of the first phase of the Plan implementation where it can be evaluated in conjunction with the project prioritization and financing discussion.

6.3.2 Environmental Review

Proposed projects are required to comply with the California Environmental Quality Act (CEQA). It is not the intent of this Plan to make recommendations for regional network improvements that would result in significant impacts to traffic, biological resources, or other environmental factors. During design and environmental review of individual planned segments, project proponents may elect to modify alignment of corridor

segments to avoid and minimize impacts. Any changes to the regional network will be documented during the Plan update, which is proposed at intervals of every four years.

6.3.3 Project Financing

The Plan identifies a cost of \$419 million to implement the regional bicycle network, and \$246 million for the constrained revenue network. The revenue estimate for the *TransNet* and TDA Active Transportation Program through the end of the *TransNet* program in FY 2048 is \$340.6 million, which means a significant portion of the regional network could be funded with the *TransNet* and TDA funds dedicated for active transportation provided completing the regional network were made the first priority for the use of these funds. However, considerable additional funding sources will be required to augment *TransNet* and TDA funds.

A simple comparison of projected annual *TransNet* and TDA Active Transportation Program revenues to total estimated network project costs suggests that the regional bicycle network could be completed in approximately 40 years if all these revenues were dedicated to constructing the network and if all available Transportation Enhancement (TE) funds are added to the funding plan as a revenue source for regional network development, with a three percent growth in TE funds assumed for each new federal authorization. How to prioritize funding the regional network and programs in comparison to local bicycle, pedestrian and neighborhood safety projects will be a policy decision to be addressed in the initial implementation phase of the Plan.

An alternative funding scenario that would enable an accelerated schedule for project development would be to utilize the *TransNet* program's financing capacity to borrow against future Active Transportation Program revenues. The regional projects could be financed as part of SANDAG's periodic bond sales or other financing mechanisms. This approach could reduce the impact of developing the regional network on the Active Transportation Program funds to the debt service obligations spread out over the remaining years of the *TransNet* program, leaving more funds for local projects in the early years. A debt financing strategy will be evaluated as an early implementation item once a priority list of projects and associated project costs has been established.

6.4 Program Monitoring

The Plan provides a long-term vision for the development of a regionwide bicycle network that can be used by all residents for all types of trips. Implementation of the Plan will take place incrementally over many years.

The following actions and measures of effectiveness are provided to guide SANDAG toward the vision identified in the Plan.

6.4.1 Regularly Revisit Project Prioritization

Projects will be prioritized based on bicycling demand, facility deficiencies, public comment, and a host of other criteria. This list should be reviewed every fiscal year, with new projects added, completed projects removed, and the priorities revised as conditions change.

6.4.2 Update the Plan

While the Plan is intended to guide the SANDAG's bicycle planning for the next 40 years, it should be reviewed and updated on a regular basis. The Plan should be updated on a four year cycle consistent with the requirement for updating the RTP.

6.4.3 Establish Measures of Effectiveness

Measures of effectiveness are used as a quantitative way to measure the region's progress toward implementing the Plan. Well-crafted measures of effectiveness will allow the region to determine the degree of progress toward meeting the Plan's goals, and include time-sensitive targets for SANDAG to meet. Chapter 4 includes a discussion of a monitoring and evaluation program.

Table 6.5 describes several measures that SANDAG may consider. These measures were developed based on known baseline conditions. Goal targets, when given, are developed based on reasonable expectations within the time frame. As new baseline information is made available, and SANDAG implements more of the Plan, the measures of effectiveness should be reevaluated, revised, and updated. SANDAG should regularly review the progress made toward these goals, preferably on an annual or biennial basis.

Table 6.5
Potential Measures of Effectiveness

Measure	Existing Benchmark (if available)	Target
Bicycle mode share	Benchmark data to be established.	By 2012 increase the percentage of people who bike for utilitarian purposes by 50%.
Public attitudes about biking in San Diego	The survey conducted as part of the Regional Bicycle Plan public input process provides some information, but a survey specifically geared toward attitudes of bikers, non-bikers, walkers and non-walkers should be developed.	Increase in positive attitudes about biking and about bicycle facilities.
Number of miles of bike paths, lanes and routes	106.9 miles of bike paths 784.6 miles of bike lanes 250.4 miles of bike routes	Increase in bicycle facilities
Proportion of Arterial Streets with Bike Lanes	Benchmark data to be established.	Increase in the proportion of arterial streets with bicycle facilities. Suggested target of 25% by 2017 to spur greater bicycle commuting.
Percentage of Elementary Schools with Safe Routes to Schools Programs	Benchmark data to be established.	100% of elementary schools participating in Safe Routes to Schools Program by 2015
Independent recognition of Non-Motorized Transportation Planning Efforts	No Bicycle Awards to Date	Independent recognition of efforts to promote biking by 2012. League of American Cyclist's Bronze Award by 2017 and Silver or Gold Award by 2027.
Number of collisions involving bicyclists and drivers	2005: 834 bike 2006: 853 bike 2007: 704 bike <i>Source: SWITRS</i>	Annual reduction in bicycle collision rate per capita

Source: Alta Planning + Design, April 2009

7 Bicycle Design Guidelines

This chapter provides design guidelines gathered from local, state and national best practices. It is intended to serve as a guide for city planners, engineers, and designers when designing and constructing bicycle facilities in the San Diego region. The design guidelines presented in this chapter are a combination of minimum standards outlined by the *California Highway Design Manual's* Chapter 1000, recommended standards prescribed by the American Association of State Highway and Transportation Officials (AASHTO) *Guide for the Development of Bicycle Facilities* and the *California Manual of Uniform Traffic Control Devices (California MUTCD)*. The minimum standards and guidelines presented by Chapter 1000 and AASHTO provide basic information about the design of bicycle facilities, such as bicycle lane dimensions, striping requirements and recommended signage and pavement markings. These guidelines also include recommendations for optional design treatments that are not intended to represent a minimum or maximum accommodation or to replace any existing adopted roadway design guidelines. Also included in these guidelines are experimental or nonstandard best practices with information about optional innovative bikeways and support facilities that have not been adopted by the *California MUTCD* or by the State of California for use in California and do not currently meet *Highway Design Manual, Chapter 1000* design requirements.

Final design of any bikeway should be conducted by a licensed engineer using sound engineering judgment and applicable standards and guidelines.

- 7.1 **Design References** lists the documents used to develop the San Diego region bicycle facility guidelines.
- 7.2 **Design Principles** describes the principles that should be used in implementing the San Diego region design guidelines.
- 7.3 **Standard Designs of Bicycle Facilities** provides general descriptions of California bikeway classifications, standard treatments, and standard signage.
- 7.4 **Innovative Treatments and Signage** presents treatments and signage that are intended to enhance safety but are not standard in California according to the *California MUTCD* or *Caltrans Highway Design Manual, Chapter 1000*.
- 7.5 **Bicycle Parking** describes guidelines for placing bicycle parking, and design guidelines for bicycle racks, bicycle lockers, and high-volume bicycle parking options such as bicycle corrals and bike stations.

7.1 Design References

The bikeway design principals outlined in this chapter are derived from the regional, state, and national documents listed below. Many of these documents are available online and provide a wealth of information and resources to the public.

- Highway Design Manual, Chapter 1000: Bikeway Planning and Design (California Department of Transportation, 2006). <http://www.dot.ca.gov/hq/oppd/hdm/pdf/chp1000.pdf>
- California Manual of Uniform Traffic Control Devices for Streets and Highways, Part 9: Traffic Controls for Bicycle Facilities (California Department of Transportation, 2006). <http://www.dot.ca.gov/hq/traffops/signtech/mutcdsupp/pdf/camutcd/CAMUTCD-Part9.pdf>
- Guidelines for the Development of Bicycle Facilities (American Association of State Highway and Transportation Officials, 1999). <http://www.transportation.org/>
- Federal Highway Administration Best Practices Design Guide Part 2, Designing Sidewalks and Trails for Access (FHWA Pub# FHWA-EP-01-027, 1001)
- AASHTO Green Book: Policy on Geometric Design of Streets and Highways (American Association of State Highway and Transportation Officials, 2001). www.transportation.org
- Bike Lane Design Guide (City of Chicago and Pedestrian and Bicycle Information Center, 2002). http://www.bicyclinginfo.org/pdf/bike_lane.pdf
- Bicycle Parking Design Guidelines (Association of Pedestrian and Bicycle Professionals, 2002). <http://www.bicyclinginfo.org/pdf/bikepark.pdf>
- Pedestrian and Bicycle Facilities in California: A Technical Reference and Technology Transfer Synthesis for Caltrans Planners and Engineers (California Department of Transportation, 2005)
- Innovative Bicycle Treatments (Institute of Transportation Engineers, 2003)
- Bicycle Boulevard Design Tools and Guidelines (City of Berkeley, 2000)
- Bicycle Boulevards Technical Memorandum (Alta Planning + Design, 2007)

- Cycle Tracks: Lessons Learned (Alta Planning + Design; Burchfield, Robert, 2008)

All bikeway facilities are required at a minimum to meet the design guidelines outlined in the *Highway Design Manual, Chapter 1000* and in the *California MUTCD*. Jurisdictions in the San Diego region are encouraged to consider application of the innovative design treatments where appropriate. When using design treatments not approved by the *California MUTCD* and the *Highway Design Manual, Chapter 1000*, agencies in the San Diego region must follow the protocol for testing innovative treatments specified by the State.

7.2 Design Principles

The following key principles were followed in developing the San Diego regional bicycle network as proposed in this plan:

- The San Diego region will have a complete and interconnected network of on-street bicycling facilities and shared-use paths that will provide bicycle access across the region to a broad range of bicycle users.
- All roads in the San Diego region are legal for the use of bicyclists, (except those roads designated as limited access facilities which prohibit bicyclists). This means that most streets are bicycle facilities, and will be designed and maintained accordingly.
- The San Diego region should strive for ‘complete streets’ as called for by the California Complete Streets Act of 2008. Complete streets are designed to safely accommodate all users, including bicyclists, pedestrians, transit riders, children, older people, and disabled people, as well as motorists.

Design guidelines are intended to be flexible and should be applied with professional judgment by licensed engineers. In this manual, design guidelines approved by the *California MUTCD* and the *Highway Design Manual, Chapter 1000* are differentiated from innovative design treatments that are not yet approved. When using design treatments not approved by the standard regulatory documents, agencies in the San Diego region must follow the protocol for testing innovative treatments specified by the State.

7.3 Standard Designs of Bicycle Facilities

According to Caltrans, the term “bikeway” encompasses all facilities that provide primarily for bicycle travel. Caltrans has defined three types of bikeways in the *Highway Design Manual, Chapter 1000*: Class I, Class II, and Class III. For each type of bikeway facility both “Design Requirements” and “Additional Design Recommendations” are provided. “Design

Requirements” contain requirements established by *Highway Design Manual, Chapter 1000*, including minimum dimensions, proper pavement markings, signage and other design treatments for bicycle facilities. “Additional Design Recommendations” are provided as guidelines to assist with design and implementation of facilities and include alternate treatments approved or recommended but not required by Caltrans. This section provides an overview of these standard bicycle facilities.

Class II Bike Lanes	
Description	
<p>A bike lane or Class II bikeway is defined as a portion of the roadway that has been designated by striping, signage, and pavement markings for one-way bicycle travel on either side of a street or highway. The following graphics show examples of typical bike lane configurations, including standard signage and required lane striping.</p>	
Graphics	
<p>4" Stripe 6" Stripe 10-12' 5' min Parking</p> <p>Bike Lane with On-Street Parallel Parking</p> <p><i>Source: Alta Planning + Design, 2009</i></p>	<p>R26 No Parking Sign R81 Bike Lane Sign 10-12' 5' min</p> <p>Bike Lane with No On-Street Parking</p> <p><i>Source: Alta Planning + Design, 2009</i></p>

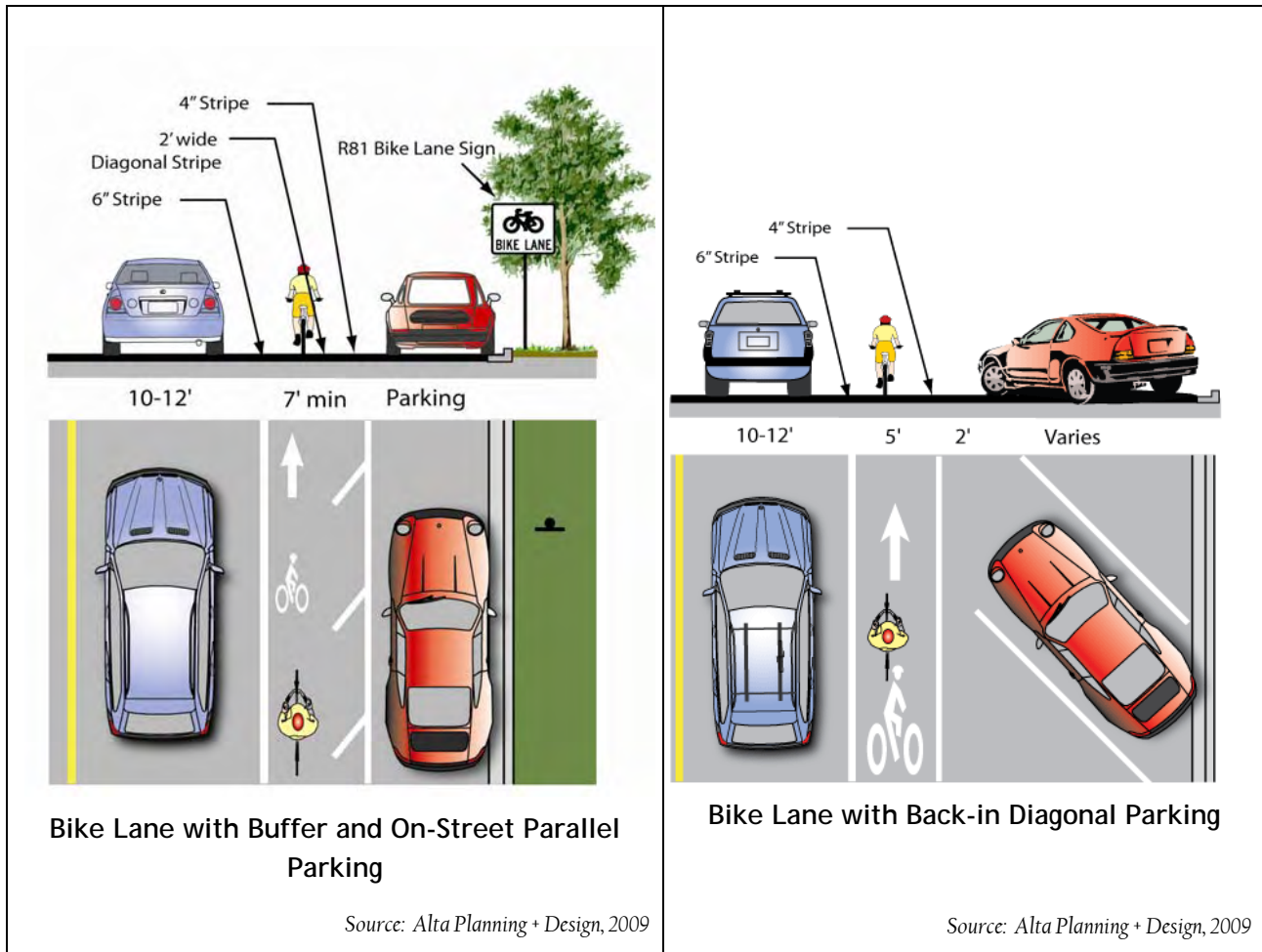

General Guidelines

The width of the bike lanes vary according to parking and street conditions. Note that these dimensions are for reference only, and are subject to engineering design review.

- 4 feet (1.2 m) minimum width if no gutter exists, measured from edge of pavement;
- 5 feet (1.5 m) minimum width with normal gutter, measured from curb face; or 3' (0.9 m) measured from the gutter pan seam;
- 5 feet (1.5 m) minimum width when parking stalls are marked; and
- 11 feet (3.4 m) minimum width for a shared bike/parking lane where parking is permitted but not marked on streets without curbs; or 12 feet (3.7 m) for a shared lane adjacent to a curb face.
- Bicycle lanes shall be comprised of a 6 inch solid white stripe on the outside of the lane, and a 4 inch solid white stripe on the inside of the lane.
- Where on-street parking is allowed, bicycle lanes must be striped between the parking area and the travel lanes.
- In cases where there is insufficient space for a bike lane, cities may recommend removing a traffic lane, narrowing traffic lanes, or prohibiting parking.
- The R81 (CA) bicycle lane sign shall be placed at the beginning of all bicycle lanes, on the far side of arterial street intersections, at all changes in direction and at a maximum of 0.6 mile intervals. All standard signage is shown in Chapter 9 of the 2006 *California MUTCD*.

Additional Discussion

Intersections represent a primary collision point for bicyclists. Small intersections with few lanes are relatively easy to manage. Large, multi-lane intersections are more difficult for bicyclists to travel through than smaller, two-lane intersections. Road striping and signage can be used to accommodate bicyclists at critical locations. Figures 9C1 and 9C3 of the California MUTCD provide standard treatment options for intersections with right-turn only and left-turn only lanes. Design solutions for bicyclists at large signalized intersections include:



- Signals should be timed to allow slower-moving bicyclists to travel across the intersection per the recommendations in the California Manual for Uniform Traffic Control Devices;
- Loop detectors or video detection that is used to actuate the signal should be calibrated to detect bicyclists;
- Loop detector stencils should be used to show bicyclists where to position themselves to actuate signals using properly calibrated loop detectors;
- Bike boxes and/or warning signage may be used to assist bicyclists who wish to turn left and are required to travel across several motor vehicle lanes to reach the left hand turn lane;
- Warning signage may be used to assist bicyclists who are traveling straight and have to merge across motor vehicle traffic that is turning right from a right-turn lane;
- Design treatments can help bicyclists travel through intersections and alert motorists of bicyclists' presence. Good intersection design alerts motorist to bicyclists, indicates to motorists and bicyclists where bicyclists may ride, and guides bicyclists through intersections.

Typical Class III Bike Routes

Description

A bike route or Class III bikeway provides routes through areas not served by Class I or II facilities or to connect discontinuous segments of a bikeway. Class III facilities can be shared with either motorists on roadways or pedestrians on a sidewalk (strongly discouraged) and is identified only by signing. There are no recommended minimum widths for Class III facilities, but when encouraging bicyclists to travel along selected routes, traffic speed and volume, parking, traffic control devices, and surface quality should be acceptable for bicycle travel. Although it is not a requirement, a wide outside traffic lane (14 feet) is typically preferable to enable cars to safely pass bicyclists without crossing the centerline. *Highway Design Manual, Chapter 1000* provides details regarding the design requirements for placement and spacing of bicycle route signage.

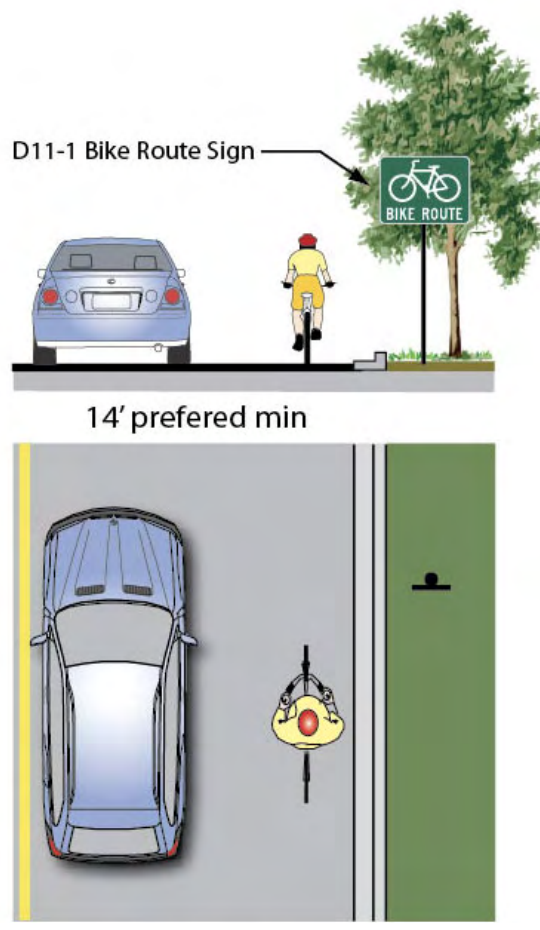
Graphics

 <p>D11-1 Bike Route Sign</p> <p>14' preferred min</p> <p>Bike Route with Wide Outside Lane</p> <p><i>Source: Alta Planning + Design, 2009</i></p>	 <p>D11-1 Bike Route Sign</p> <p>Local Street - Width Varies</p> <p>Bike Route on Minor Roadway</p> <p><i>Source: Alta Planning + Design, 2009</i></p>
--	---

Enhanced Class III - Shared Lane Arrow Markings (SLMs)

Description

In September 2005, the “shared lane marking” was approved by the California Traffic Control Devices committee for use by California jurisdictions.²⁵ The primary purpose of the shared lane marking (sometimes referred to as “sharrows”) is to provide positional guidance to bicyclists on roadways that are too narrow to be striped with bicycle lanes and to alert motorists of the location a cyclist may occupy on the roadway. Shared lane markings are intended to reduce the chance of a cyclist colliding with an open car door of a vehicle parked on-street, parallel to the roadway. The *California MUTCD* only allows shared lane markings to be used on urban roadways with on-street parallel parking. The next version of the national *MUTCD* will include shared lane markings, and will allow them to be included at all locations, not just next to parked cars.

Graphics

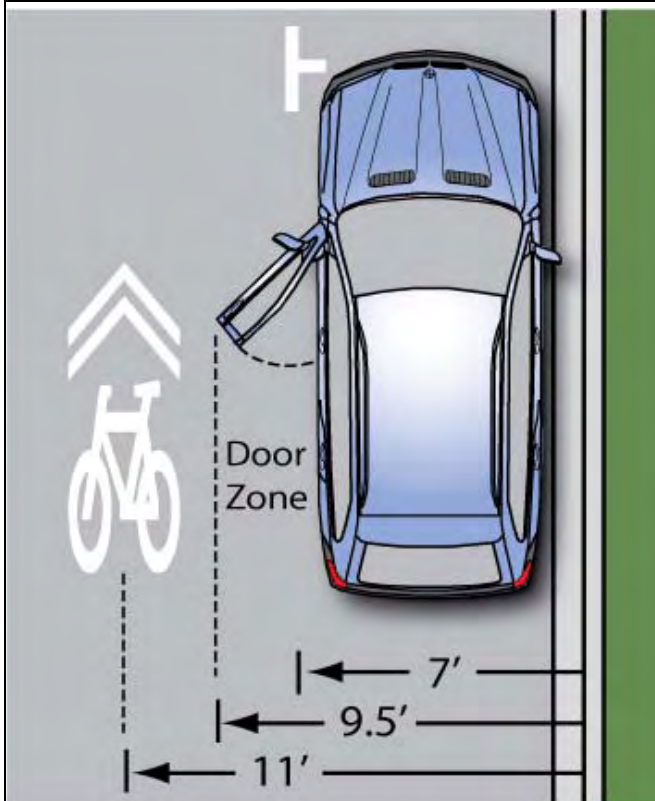

Recommended Sharrow Placement

Source: *Alta Planning + Design, 2009*



Sharrow on a residential street

²⁵ Policy Directive 05-10 “Shared Roadway Bicycle Marking”, passed on September 12, 2005, outlines implementation guidelines for placing Shared Lane Markings. <<http://www.dot.ca.gov/hq/traffops/signtech/signdel/policy.htm>>

General Guidelines

Shared lane markings are appropriate on bicycle network streets that are:

- Too narrow for standard striped bicycle lanes;
- Areas that experience a high level of "wrong-way" riding; or
- Streets that have moderate to high parking turnover, typically in commercial areas.
- There is increasing interest in applying sharrows in conjunction with bike lanes on steeper slope roadways. Bike lanes are placed on the uphill side of the roadway and sharrows are placed on the downhill side of the roadway to encourage fast moving bicyclists to position themselves away from parked cars.
- Shared lane arrow markings should be installed in conjunction with "share the road" signs
- Arrows should be spaced approximately 200' center to center, with the first arrow on each block or roadway segment placed no further than 100' from the nearest intersection.

Bicycle Boulevards

Description

Bicycle boulevards are local roads or residential streets that have been enhanced with treatments to facilitate safe and convenient bicycle travel. These facilities accommodate bicyclists and motorists in the same travel lanes, typically without specific vehicle or bicycle lane delineation. Bicycle boulevards prioritize bicycle travel above vehicular travel. The treatments applied to create a bike boulevard heighten motorists' awareness of bicyclists and slow vehicle traffic, making the boulevard more conducive to safe bicycle and pedestrian activity. Bicycle boulevards have been implemented in a variety of locations including Berkeley, Palo Alto and Davis California, and Portland, Oregon.

Graphic

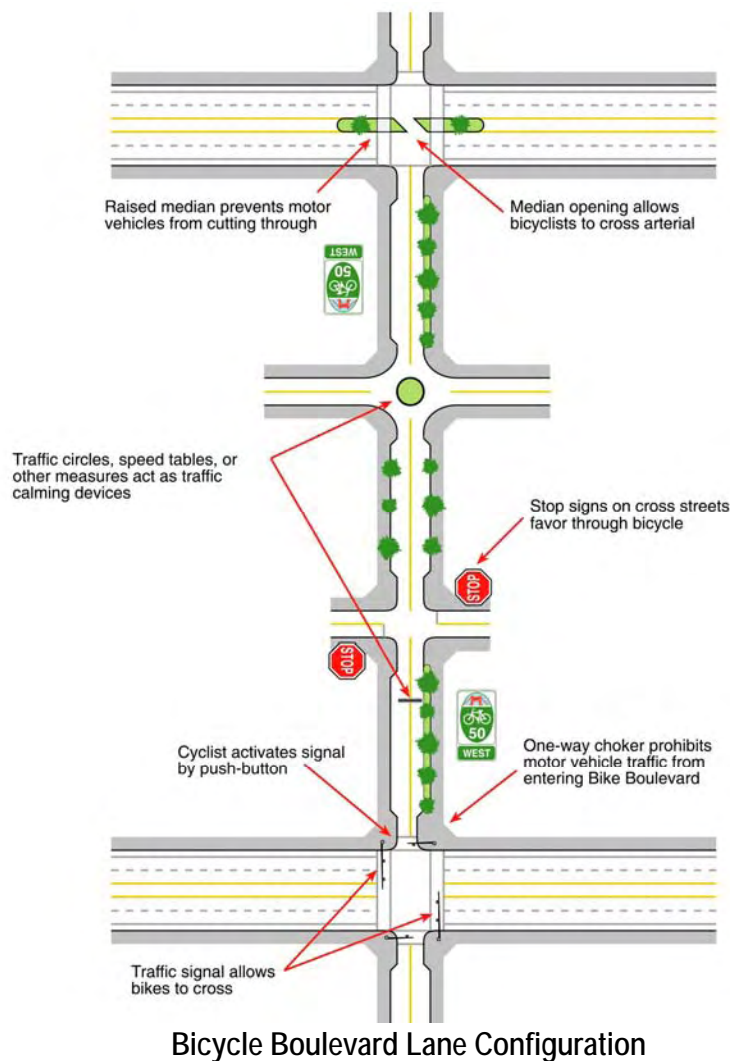

Note: The installation of traffic calming measures requires local government agency approval.

Source: *Alta Planning + Design, 2009*

General Guidelines

Bicycle boulevards typically include the following design features:

- Traffic calming devices such as traffic circles and curb bulbouts;
- Bicycle destination signage;
- Pavement stencils indicating status as a bicycle boulevard;
- Crossing improvements at major arterials such as traffic signals with bicycle-detection, four-way stops and high-visibility crosswalks;
- Bicycle-friendly signal preemption at high-volume signalized intersections;
- Stop signs on streets crossing the bicycle boulevard; and
- Some jurisdictions have implemented bicycle boulevards by removing on-street parking in select locations.

Bicycle boulevards can be designed to accommodate the particular needs of the residents and businesses along the routes, and may be as simple as pavement markings with wayfinding signs or as complex as a street with traffic diverters and bicycle signals. Bike boulevards with signage only typically require extensive public education to be effective.

To further identify a street as a preferred bicycle route, lower volume roadways may be modified to function as a through street for bicycles, while maintaining only local access for automobiles. Traffic calming devices can lower traffic speeds and through trips, limiting conflicts between motorists and bicyclists and providing priority to through bicycle movement.

For more information, see:

- City of Berkeley Bicycle Boulevard Design Tools and Guidelines:
<http://www.ci.berkeley.ca.us/transportation/Bicycling/BB/Guidelines/linkpag.htm>;
- Bicycle Transportation Alliance Bicycle Boulevards Campaign:
http://www.bta4bikes.org/at_work/bikeboulevards.php
- Draft 2009 AASHTO Guide for the Development of Bicycle Facilities
- Bicycle Boulevard Design Guidebook (forthcoming publication of the Portland State University Initiative for Bicycle and Pedestrian Innovation (IBPI) and Alta Planning + Design.



Traffic calming on bicycle boulevards

Class I Bike Path (Shared-Use Path)

Description

Typically called a “bike path” or “shared-use path,” a Class I bikeway provides bicycle travel on a paved right-of-way completely separated from any street or highway. In locations with high use, or on curves with limited sight distance, a yellow centerline should be used to separate travel in opposite directions. High use areas of the trail should also provide additional width of up to 12 feet. Lighting should be provided in locations where evening use is anticipated or where paths cross below structures.

Graphics

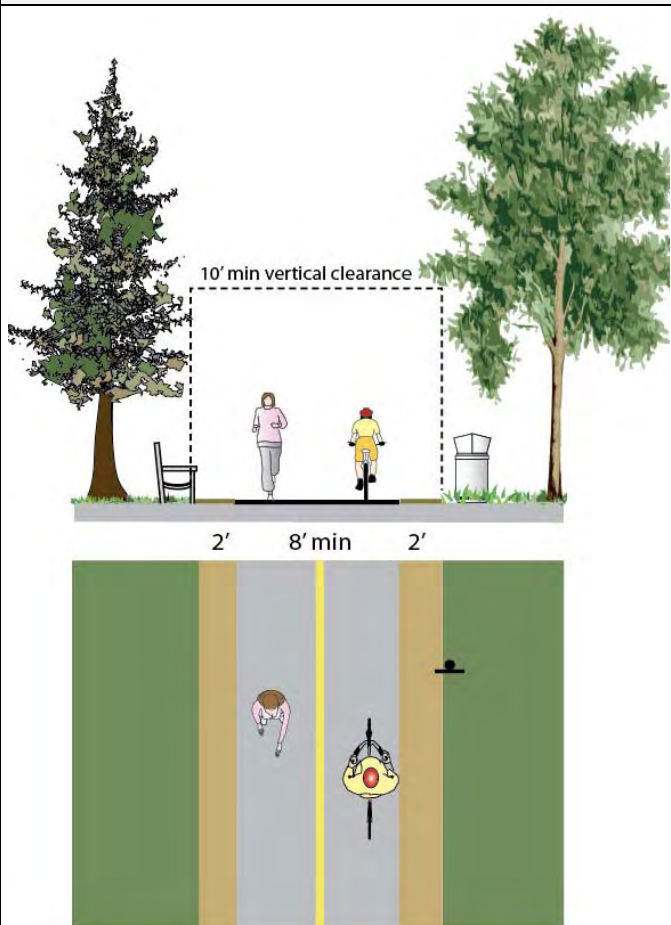

Shared-Use Path Example

Source: Alta Planning + Design, 2009

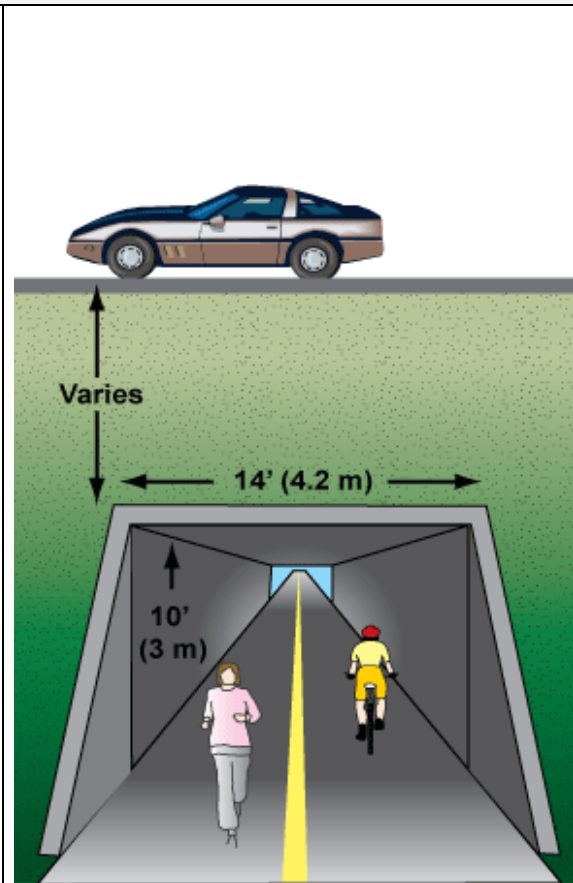

Shared-Use Path Undercrossing

Source: Alta Planning + Design, 2009

General Guidelines

The recommended width of a shared-use path is dependent upon anticipated usage:

- 8 feet (2.4 m) is the minimum width for Class I facilities.
- 8 feet (2.4 m) may be used for short neighborhood connector paths (generally less than one mile in length) due to low anticipated volumes of use.
- 10 feet (3.0 m) is the recommended minimum width for a typical two-way shared-use path.
- 12 feet (3.7 m) is the preferred minimum width if more than 300 users per peak hour are anticipated, and/or if there is heavy mixed bicycle and pedestrian use.
- A minimum 2' (0.6 m) wide graded area must be provided adjacent to the path to provide clearance from trees, poles, walls, guardrails, etc.
- Paths should be constructed with adequate sub grade compaction to minimize cracking and sinking, and should be designed to accommodate appropriate loadings, including emergency vehicles.
- A 2% cross slope shall be provided to ensure proper drainage.
- 8 feet (2.4 m) is the required minimum clearance from overhead obstructions, with 10 feet (3.0 m) recommended.

GRADE INTERSECTION:

When shared-use paths cross streets, proper design should be developed on the pathway as well as on the roadway to alert bicyclists and motorists of the crossing. Sometimes on larger streets, at mid-block pathway crossing locations, an actuated signal is necessary. A signal allows bicyclists a clear crossing of a multi-lane roadway. If a signal is or is not needed, appropriate signage and pavement markings should be installed, including stop signs and bike crossing pavement markings.

OVERCROSSINGS:

Overcrossings are also an important component of bikeway design. Barriers to bicycling often include freeways, complex interchanges, and rivers. When a route is not available to cross these barriers a bicycle overcrossing is necessary.

Some design considerations for overcrossings include:

- Pathways must be a minimum 6 feet (1.8 m) wide, with a preferred width of 8 feet (2.4 m) or 10 feet (3.0 m) wide;
- Slope of any ramps must comply with ADA Guidelines; and
- Screens are often a necessary buffer between vehicle traffic and the bicycle overcrossing.

UNDERCROSSINGS:

Undercrossings are an important component of Class I bikeway design. Some considerations for undercrossings include:

- Must have adequate lighting and sight distance for safety;
- Must have adequate over-head clearance of at least 10 feet (3.0 m);
- Tunnels should be a minimum width of 14 feet (4.3 m) for several users to pass one another safely; a 10 feet x 20 feet (3.0 m x 6.1 m) arch is the recommended standard;
- "Channeling" with fences and walls into the tunnel should be avoided for safety reasons; and
- May require drainage if the sag point is lower than the surrounding terrain.

Bicycle Signals & Adaptive Signal Timing

Description

Making intersections more “friendly” to bicyclists, involves modifying how they operate. Improved signal timing, calibrating loop detectors to detect bicyclists, and camera detection makes intersections easier for bicyclists to cross intersections.

Bicycle loop detectors activate traffic signals at intersections, similar to standard loop detectors used for auto traffic. Where bicycle loop detectors are not present, bicyclists are forced to wait for a motor vehicle to trigger a signal; where motor vehicle traffic is infrequent, they may cross against a red signal. Bicycle loop detectors should be identified with pavement markings that show cyclists where to position themselves to trigger the traffic signal.

A bicycle signal provides an exclusive signal phase for bicyclists traveling through an intersection. This takes the form of a new signal head installed with red, amber, and green bicycle indications. Bicycle signals can be actuated with bicycle sensitive loop detectors, video detection, or push buttons. Bicycle signals became an approved traffic control device in the state of California after the technology was studied after years of service in the City of Davis. Part 4 of the *California MUTCD* covers bicycle signals.

Graphics



Bicycle signal



Bicycle loop detector stencil

General Guidelines

Bicycle signals are typically considered in locations with heavy bicycle traffic combined with significant conflicts with motor vehicles, at intersections with unique geometry or at the interface between busy roads and off-street bicycle facilities. Specific situations where bicycle signals have had a demonstrated positive effect include:

- Locations with high volume of bicyclists at peak hours;
- Locations with high numbers of bicycle/motor vehicle crashes, especially those caused by crossing paths;
- At T-intersections with major bicycle movement along the top of the T;
- At the confluence of an off-street bike path and a roadway intersection; and
- Where separated bike paths run parallel to arterial streets.

While bicycle signals are approved for use in California, local municipal code should be checked or modified to clarify that at intersections with bicycle signals, bicycles should only obey the bicycle signal heads.

On-Street Bikeway Signage

Description

Standard signage for on-street bikeways includes standard BIKE LANE and BIKE ROUTE signage, as well as supplemental signage such as SHARE THE ROAD and warning signage for constrained bike lane conditions. Engineers should consult the *California MUTCD* for the full spectrum and applicability of signage options.

Graphics



Potential Signage Options for Bike Routes/Bicycle Boulevards
(not comprehensive)

Source: California MUTCD



Berkeley, CA bike boulevard signage



San Francisco, CA route identification signage

Additional Discussion

Wayfinding signage is an important part of the bicycle network. Implementing a well-planned and attractive system of signage can greatly enhance bikeway facilities, making their presence aware to motorists, as well as existing and potential bicyclists. By leading people to city bikeways that offer safe and efficient transportation, effective signage can encourage residents and visitors to bicycle. Way-finding can include mile-markers, route identification, and informational kiosks.

Destination signage helps bicyclists use the bikeway network as an effective transportation system. These signs typically display distance, direction and in some cases, estimated travel time information to various destinations and activity centers. In the San Diego region, destination signage would be helpful for destinations such as downtown, Balboa Park, UCSD, and beaches. Signage can also assist users to navigate towards major bikeways, transit hubs, or greenway trails. Finally, way-finding can help bicyclists avoid difficult and potentially hazardous road scenarios, like steep terrain, dangerous intersections, highway and river crossings, or deteriorating road conditions.

Wayfinding and bike route network signage is recommended for the San Diego region. *California MUTCD* defines standards for these route network signs. Most commonly, they show the route number and the corresponding direction. Route naming and numbering should be coordinated between neighboring jurisdictions where bikeways cross cities' boundaries so that the regional signage system is seamless.

For bike route signs, *California MUTCD* requires a green background and white lettering. The top third portion of the sign is customizable for the city or region where it is located. For example, the City of San Francisco shows the Golden Gate Bridge on its bike route signs.

The multi-use path network should be integrated with on-street bike facility signage to encourage use of paths for recreational as well as utilitarian bicycling; helping bicyclists of all ages and abilities reach destinations more easily.

Informational kiosks, complete with maps of the surrounding area, can help provide initial orientation and bearings for bicyclists beginning their journeys at major transit hubs, or transitioning from off-street to on-street facilities.

7.4 Innovative Treatments and Signage

The following section describes facilities and treatments that are intended to enhance safety but are not adopted as standard treatments by the *California MUTCD* or *Caltrans Highway Design Manual*.

Bike Boxes	
Description	
<p>A bike box is a relatively simple innovation to improve turning movements for bicyclists without requiring cyclists to merge into traffic to reach the turn lane or use crosswalks as a pedestrian. The bike box is formed by pulling the stop line for vehicles back from the intersection, and adding a stop line for bicyclists immediately behind the crosswalk. When a traffic signal is red, bicyclists can move into this “box” ahead of the cars to make themselves more visible, or to move into a more comfortable position to make a turn. Bike Boxes are not included in the <i>California MUTCD</i>.</p>	
Graphic	
 <p>Possible Bike Box Configuration</p> <p><i>Source: Alta Planning + Design, 2009</i></p>	 <p><i>Examples of bike boxes</i></p>

General Guidelines

- Apply at intersections with a high volume of bicycles and motor vehicles.
- Apply where there are frequent turning conflicts and/or intersections with a high percentage of turning movements by both bicyclists and motorists.
- California MUTCD signage should be present to prevent 'right turn on red' and to indicate where the motorist must stop.
- In the US, bicycle boxes have been used in Cambridge, MA, Portland, OR and Eugene, OR. They have been used in a variety of locations throughout Europe.

Colored Bike Lanes in Conflict Areas

Description

European countries have used colored pavement – red, blue, yellow, and green—for bike lanes where this is a higher probability of vehicle conflicts. Examples of such locations are freeway on- and off-ramps where motorists move into a right turn pocket. In the United States cities such as Portland and Seattle have experimented with colored bike lanes and supportive signage with favorable results. Studies conducted in Portland showed that more motorists were using their turn signals and slowing or stopping at the blue lanes. Colored Bike Lanes are not included in the *California MUTCD*.

Graphics

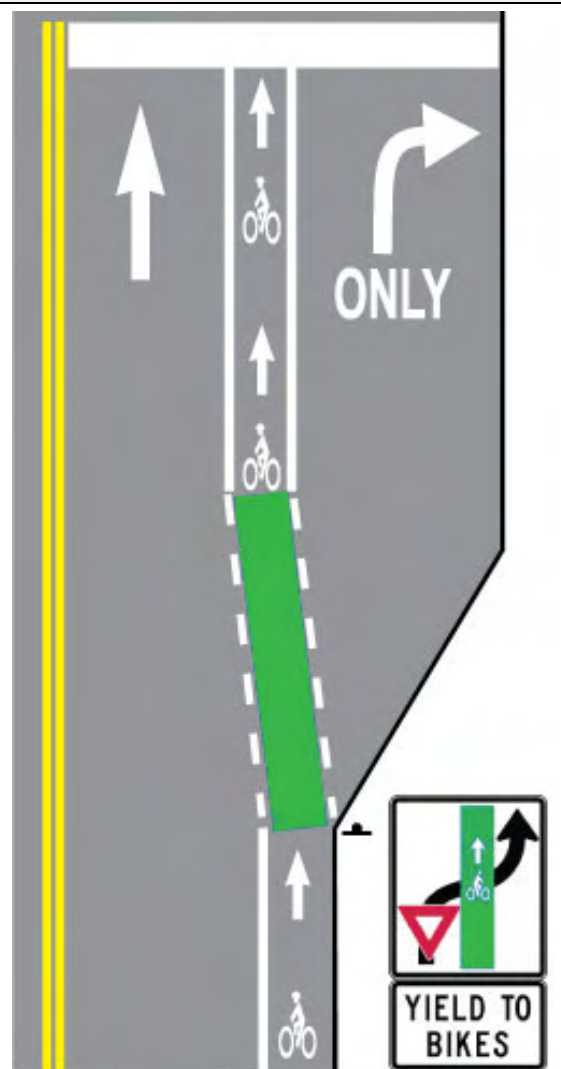

Colored Bike Lane Configuration

Source: Alta Planning + Design, 2009



Examples of colored bike lanes in U.S. cities

General Guidelines

- This treatment is not currently present in any State or Federal design standards.
- Colored bike lanes are used to guide bicyclists through major vehicle/bicycle conflict points, especially at locations where the volume of conflicting vehicle traffic is high, and where the vehicle/bicycle conflict area is long.
- Colored bike lanes typically extend through the entire bicycle/vehicle conflict zone (e.g., through the entire intersection, or through the transition zone where motorists cross a bike lane to enter a dedicated right-turn lane).
- Portland's Blue Bike Lanes: <http://www.portlandonline.com/shared/cfm/image.cfm?id=58842>

Cycle Tracks

Description

Cycle tracks are receiving increasing levels of interest and attention from planners and engineers in the United States, although they are not currently considered a standard facility type. *The Highway Design Manual, Chapter 1000* does not define cycle tracks as a bikeway or include provisions for cycle track designs. Cycle tracks are physically separated one-way (or two-way) bike lanes in the roadway right-of-way. These bikeways are located between sidewalks and vehicle travel lanes or parking lanes and are a delineated area specifically for through bicycle traffic. Cycle tracks can be at the same plane as sidewalks but are usually separated by a low curb or barrier. There should be sidewalks adjacent to cycle tracks to prevent pedestrians from confusing cycle tracks with multi-use paths. When crossing cycle tracks, pedestrians should have the right-of-way. On the motor vehicle side of cycle tracks, if there is an on-street vehicle parking lane then there is normally a two to three foot buffer preventing car doors from entering the bikeway. If there is no on-street parking, a larger barrier is put in place to separate bicycles and automobile traffic.

Graphics

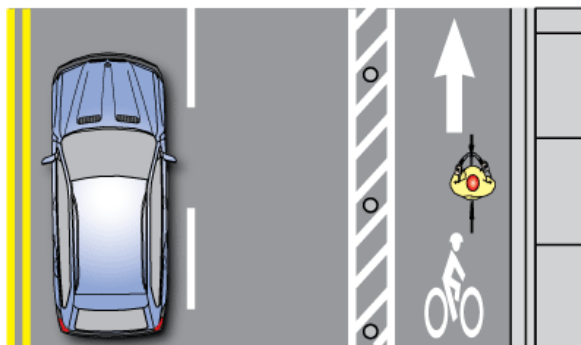
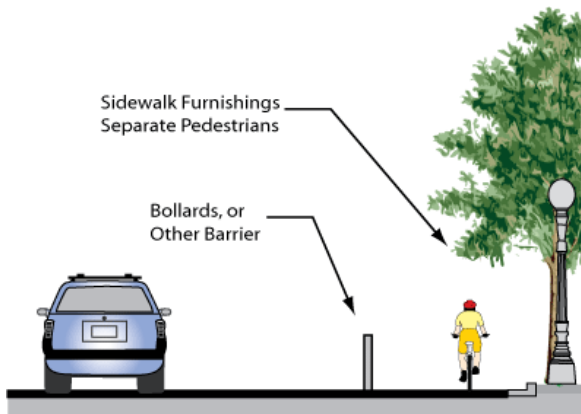

Cycle Track with No On-Street Parking

Source: Alta Planning + Design, 2008



Cycle track in New York City, NY

General Guidelines

- Cycle tracks are useful along streets with minimal crossings.
- Intersections should be designed to include signage that alerts motorists of bicyclists crossing from the cycle track, and vegetation and parking should be limited near intersections so that bicyclists and motorists can see each other.
- If cycle tracks are two-way, motorists should be alerted to the fact that bicyclists will be approaching from both directions.
- To help decrease the number of wrong-way riding bicyclists on one-way cycle tracks, complimentary facilities should be provided on the opposite side of the street.
- While cycle tracks increase bicyclists' comfort on urban and suburban streets, intersection treatments are needed to mitigate turn movement conflicts. Protective measures include retrofitting signalized intersections to provide separate left and right turn movements, adding bicycle-only signals, requiring no right-turn-on-red, and warning signage and special markings at unsignalized intersections. Other innovative treatments, such as colored pavement, can complement these facilities and improve warnings to motorists.
- For additional discussion of cycle track designs, see the white paper on cycle tracks provided in **Appendix I**.

Shared Bike-Bus Lane

Description

Travel time for bikes and buses can be improved with a dedicated shared bicycle/bus lane, so that neither is hindered or endangered by congestion from other auto traffic. Shared bicycle/bus lanes are commonly used in central business districts where room for dedicated bicycle lanes is limited, and where motor vehicle congestion warrants a separate facility for buses.

Graphic

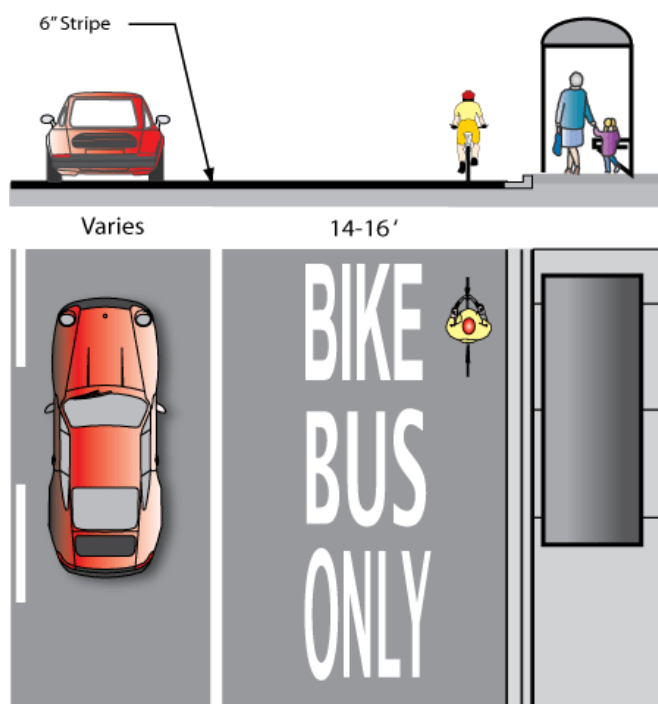

Shared Bike-Bus Configuration

Source: Alta Planning + Design, 2009



Shared Bike-Bus Signage

General Guidelines

- Potential locations for bicycle/bus lane implementation include congested streets with moderate or long bus headways, streets with moderate bus headways during peak hours, or places that provide no reasonable alternative routing alignment.
- Shared bicycle/bus lanes should be paved with colored asphalt and stenciled as a diamond lane with supporting signage and pavement legends to emphasize their designation.
- Lanes should be wide enough to allow bicyclists to comfortably pass stopped buses on the left. Twelve feet is the recommended minimum width of shared bicycle/bus lanes.
- Potential disadvantages of shared lanes include a leapfrogging between buses and bikes (when buses and bikes are continually passing one another in the lane). Leapfrogging creates a greater potential for conflicts. The second disadvantage is when vehicles are allowed to use the lane at intersections as a right turn lane. This slows and creates potential conflict points between bicycles and vehicles and slows buses and bicycles significantly.

Contra-Flow Bicycle Lanes

Description

Contra-flow bicycle lanes entail a striped lane for bicycles going against the flow of automobile travel. The lanes should be separated by a double-yellow line. *Contra-flow bike lanes are not included in the Highway Design Manual, Chapter 1000.*

Contra-flow bike lanes are designated lanes that allow bicycles to move in the opposite direction of traffic on a one-way street. Functionally, streets with contra-flow bicycle lanes are set up so that motor vehicles can only move one way on the road, while bikes can move in both directions – with traffic or opposite traffic in the contra-flow lane.

Graphic

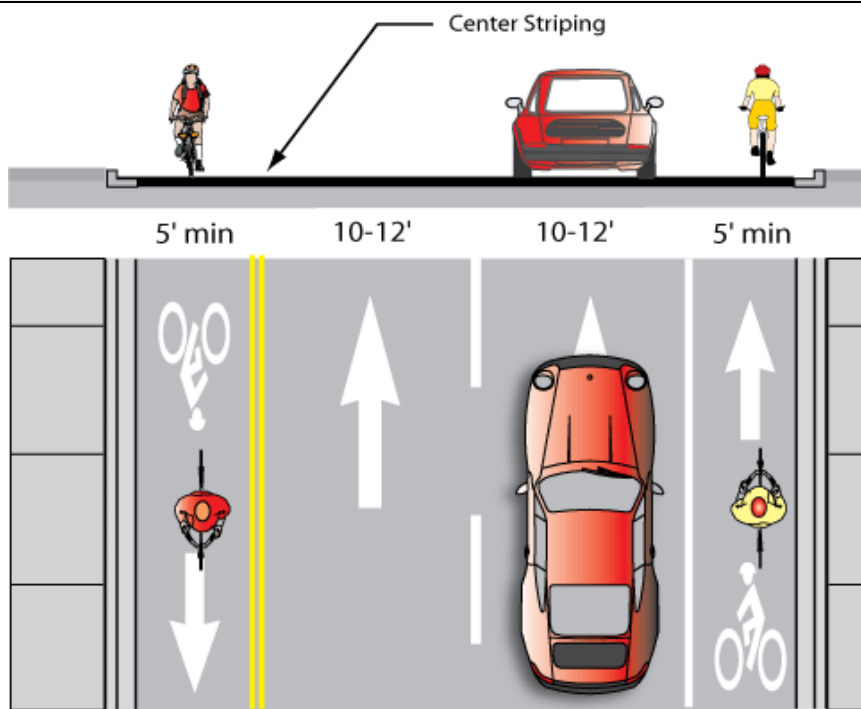

General Guidelines

Their implementation is controversial primarily because, contrary to standard road rules, they encourage cyclists to ride against motor-vehicle right of way, which can lead to increased bicycle/motor-vehicle crashes.

However, in some circumstances, they may offer substantial savings in out-of-direction travel, by providing more direct routes. For popular destinations and high-use bikeways, a contra-flow lane can increase safety by reducing the number of bicyclists, and the number of conflicts, along the longer indirect route.

Potential Applications:

- Provides direct access to key destination;
- Improves safety;
- Infrequent driveways on bike lane side;
- Bicyclists can safely and conveniently re-enter traffic at either end;
- Sufficient width to provide bike lane;
- No parking on side of street with bike lane;
- Existing high bicycle usage of street;
- Less than three blocks in length; or

No other reasonable route for bicyclist.

Contra-flow lanes are most successful on streets with few intersecting driveways, alleys or streets on the side of the lane; on streets where bicyclists can safely and conveniently re-enter the traffic stream at either end of the lane; on streets where a substantial number of bicyclists are already using the street; and on streets with sufficient width to accommodate a bike lane.

Special features to incorporate into contra-flow bike lane design include the following.

- The contra-flow bike lane must be placed on the right side of the street (to motorists' left) and must be separated from oncoming traffic by at least a double yellow line; vertical separation or grade separation is encouraged. This indicates that the bicyclists are riding on the street legally, in a dedicated travel lane.
- Any intersecting alleys, major driveways, and streets must have signs indicating to motorists that they should expect two-way bicycle traffic.
- Existing traffic signals should be fitted with actuators for bicyclists (i.e. loop detectors, video cameras, infrared or push buttons).
- Existing traffic signals should be modified (if necessary) so that bicyclists traveling in the contra-flow direction can see the signal head, and any conflicting turn phasing shall be eliminated.

Innovative Signage

Description

Innovative signage can be developed for a number of reasons – as a standardized warning system, to assist with unique way-finding, or to help lend a sense of place to a community. Some innovative signage is developed to increase awareness that bicyclists may use the full travel lane and to alert motorists to the proper response. Any signs to be installed on public roadways in California must be approved by Caltrans.

New experimental designs can be utilized after approval. This continuing process of developing better way-finding or safety-warning signs is important for designing safer and more enjoyable bicycling facilities, as well as improving the overall transportation system.

Graphics

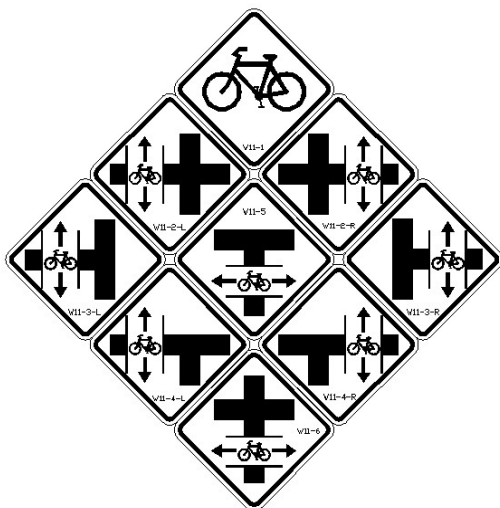

Experimental parallel path warning signage in Denver, CO



Experimental parallel path warning signage in Denver, CO



San Carlos, CA innovative sign



Innovative signage in Santa Cruz, CA

7.5 Bicycle Parking

As more bikeways are constructed and bicycle usage grows, the need for bike parking will increase. Short-term parking at shopping centers and similar land uses can support bicycling as well as long-term bicycle parking at transit stations, work sites and schools.

Bicycle parking should be installed on public property, or available to private entities on an at-cost basis. Bicycle parking facilities should be provided at other public destinations, including government buildings, community centers, parks, schools and shopping centers.

All bicycle parking should be in a safe, secure area visible to passersby. Commuter locations should provide secure indoor parking, covered bicycle corrals, or bicycle lockers. Bicycle parking on sidewalks in commercial areas should be provided according to specific design criteria, reviewed by merchants and the public, and installed as demand warrants.

Short Term Bicycle Parking

Description

Short term bicycle parking facilities are best used to accommodate visitors, customers, messengers and others expected to depart within two hours. Bicycle racks provide support for the bicycle but do not have locking mechanisms. Racks are relatively low-cost devices that typically hold between two and eight bicycles, allow bicyclists to securely lock their frames and wheels, are secured to the ground, and are located in highly visible areas. They are usually located at schools, commercial locations, and activity centers such as parks, libraries, retail locations, and civic centers.

Graphics

1. THE RACK ELEMENT

Definition: the rack element is the part of the bike rack that supports one bicycle.

The rack element should:

- Support the bicycle upright by its frame in two places
- Prevent the wheel of the bicycle from tipping over
- Enable the frame and one or both wheels to be secured
- Support bicycles without a diamond-shaped frame with a horizontal top tube (e.g. a mixte frame)
- Allow front-in parking: a U-lock should be able to lock the front wheel and the down tube of an upright bicycle
- Allow back-in parking: a U-lock should be able to lock the rear wheel and seat tube of the bicycle

Comb, toast, school-yard, and other wheel-bending racks that provide no support for the bicycle frame are NOT recommended.

The rack element should resist being cut or detached using common hand tools, especially those that can be concealed in a backpack. Such tools include bolt cutters, pipe cutters, wrenches, and pry bars.



INVERTED "U"
One rack element supports two bikes.



"A"
One rack element supports two bikes.



POST AND LOOP
One rack element supports two bikes.



COMB
One rack element is a vertical segment of the rack.



Not recommended



WAVE
One rack element is a vertical segment of the rack. (see additional discussion on page 3)



TOAST
One rack element holds one wheel of a bike.



Custom artistic racks



Inverted U rack

Bike Rack Recommendations

Source: Association of Pedestrian and Bicycle Professionals, 2002

General Guidelines

Bicycle racks should be installed with the following guidelines in mind.

- The rack element (part of the rack that supports the bike) should keep the bike upright, supporting the frame in two places and allowing one or both wheels to be secured.
- Install racks so there is enough room between adjacent parked bicycles. If it becomes too difficult for a bicyclist to easily lock their bicycle, they may park elsewhere. A row of inverted “U” racks should be installed in parallel with 15 inches minimum between racks.
- Empty racks should not pose a tripping hazard for visually impaired pedestrians. Position racks out of the walkway’s clear zone.

When possible, racks should be in a covered area protected from the elements. Long-term parking should always be protected.

Generally, ‘U’ type racks bolted into the sidewalk are preferred and should be located intermittently or in front of key destinations. Bicycle racks should be installed to meet ADA standards and not block pedestrian through traffic.

The City may want to consider custom racks that can serve not only as bicycle parking racks, but also as public artwork or as advertising for a specific business. The “post and ring” style rack is an attractive alternative to the standard inverted-U, which requires only a single mounting point and can be customized to have the city name or emblem stamped into the rings. These racks can also be easily retrofitted onto existing street posts, such as parking meter posts. While custom racks can add a decorative element and relate to a neighborhood theme, the rack function should not be overlooked: All racks should adhere to the basic functional requirement of supporting the bicycle by the frame (not only the wheel) and accepting a U-lock.



On-Street Bike Parking with Inverted U Racks

Long Term Bicycle Parking

Description

For long-term parking, the cities may want to consider bicycle lockers. Bicyclists are usually more comfortable storing their bicycles in lockers for long periods because they offer increased security and protection from natural elements. Although they may be more expensive to install, they can make the difference for commuters deciding whether or not to bicycle.

Lockers can be controlled with traditional key systems or through more elaborate subscription systems. Subscription locker programs, like e-lockers, or park-by-phone systems allow even more flexibility within locker use. Instead of restricting access for each patron to a single locker, subscribers can gain access to all lockers within a system, controlled by magnetic access cards, or caller ID. These programs typically have fewer administrative costs because they simplify or eliminate key management and locker assignment.

Long-term bicycle parking facilities accommodate employees, students, residents, commuters, and others expected to park more than two hours. This parking should be provided in a secure, weather-protected manner and location. Long-term bicycle parking will either be a bicycle locker, or a secure area like a ‘bike corral’ that may be accessed only by bicyclists.

Graphic

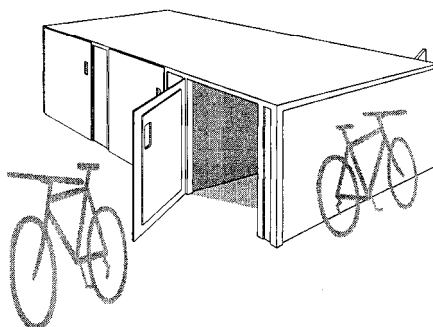
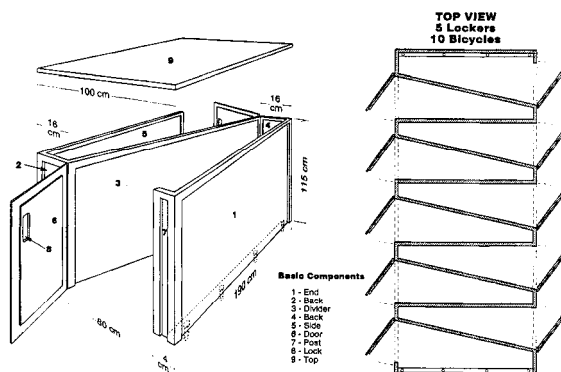

Bike Locker Configuration

Source: Alta Planning + Design, 2000

Innovative High Volume Bicycle Parking

Description

In many locations, individual U-racks located on the sidewalk can be sufficient to meet bicycle parking demand. Where bicycle parking demand is higher, more formal structures and larger facilities need to be provided. Several options for high-volume bicycle parking are outlined below.

Graphic



Bike Oasis



Bike Corral in Portland, OR



Bike Station in Chicago, IL

General Guidelines

On-Street Bike Parking Corral:

A relatively inexpensive solution to providing high-volume bicycle parking is to convert one or two on-street motor vehicle parking spaces into on-street bicycle parking. Bike racks are installed in the street and protected from motor vehicles with removable curbs and bollards. These Bike Parking Corrals move bicycles off the sidewalks, and leave space for sidewalk café tables or pedestrians. Bicycle parking does not block sightlines like motor vehicles do, so it may be possible to locate bicycle parking in no-parking zones near intersections and crosswalks.

Bike Oasis:

In 2008, the City of Portland, Oregon began installation of several “Bike Oases” in commercial districts. These signature bicycle parking facilities are installed on curb extensions and consist of attractive covered bike parking and an information panel. Portland’s Bike Oases provide parking space for ten bikes. Bike and walking maps are installed on the information panel.

Bike Stations:

Bike stations serve as one-stop bicycle service centers for bicycle commuters. They include 24-hour secure bicycle parking and may provide additional amenities such as a store to purchase items (helmets, raingear, tubes, patch kits, bike lights, and locks), bicycle repair facilities, showers and changing facilities, bicycle rentals, and information about biking. Some bike stations provide free bike parking, while others charge a fee or require membership.

Bike stations have been installed in several cities in California, including Long Beach, San Francisco, Los Angeles and Berkeley, as well as Chicago, and Seattle.

Valet Bike Parking:

The San Diego Padres currently provides bike parking in a pavilion at Sunday afternoon Padres games as does the San Diego County Bicycle Coalition (SDCBC) during other community events. To expand bike parking options, indoor locations for storing bicycles should be designed into future venues that host sporting events, festivals, and other events where large numbers of people gather.

In San Francisco, attended bicycle parking is provided at the AT&T Stadium, home of the San Francisco Giants. The bicycle valet sees between 100 and 180 bicycles per game on average (The stadium’s capacity is 41,503). In addition to providing bicycle valet parking, the City and stadium heavily promote using alternative modes to get to the stadium, emphasizing that “if you drive you will get stuck in traffic.”

Their valet parking system works much like a coat check: the bicyclist gives their bicycle to the attendant, who tags the bicycle with a number and gives the bicyclist a claim stub. The valet also will take non-motorized devices such as rollerblades, baby strollers and push scooters. When the bicyclist returns to get the bicycle, they present the claim stub and the attendant retrieves the bicycle for them. Locks are not needed. The valet is open from two hours before the game to thirty minutes after.